

Bragi

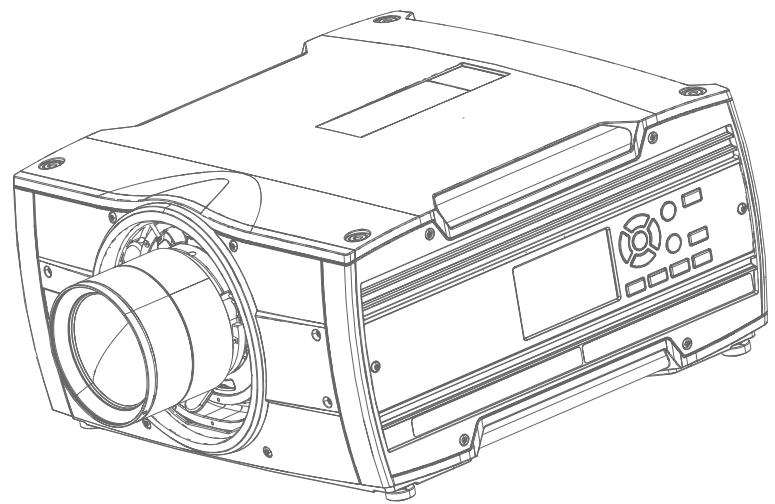

Installation Guide

Barco Fredrikstad AS

Haborneveien 53, N-1630 Gamle Fredrikstad, Norway
Support.fre@barco.com
www.barco.com

Registered office: Barco NV

President Kennedypark 35, 8500 Kortrijk, Belgium
www.barco.com/en/support
www.barco.com

Changes

Barco provides this manual 'as is' without warranty of any kind, either expressed or implied, including but not limited to the implied warranties or merchantability and fitness for a particular purpose. Barco may make improvements and/or changes to the product(s) and/or the program(s) described in this publication at any time without notice.

This publication could contain technical inaccuracies or typographical errors. Changes are periodically made to the information in this publication; these changes are incorporated in new editions of this publication.

The latest edition of Barco manuals can be downloaded from the Barco web site www.barco.com or from the secured Barco web site <https://www.barco.com/en/signin>.

Federal Communications Commission (FCC Statement)

This equipment has been tested and found to comply with the limits for a class A digital device, pursuant to Part 15 of the FCC rules. These limits are designed to provide reasonable protection against harmful interference when the equipment is operated in a commercial environment. This equipment generates, uses, and can radiate radio frequency energy and, if not installed and used in accordance with the instruction manual, may cause harmful interference to radio communications. Operation of this equipment in a residential area may cause harmful interference, in which case the user will be responsible for correcting any interference at his own expense

Changes or modifications not expressly approved by the party responsible for compliance could void the user's authority to operate the equipment

FCC responsible: Barco Inc.
3059 Premiere Parkway Suite 400
30097 Duluth GA, United States
Tel: +1 678 475 8000

Trademarks

Brand and product names mentioned in this manual may be trademarks, registered trademarks or copyrights of their respective holders. All brand and product names mentioned in this manual serve as comments or examples and are not to be understood as advertising for the products or their manufacturers.

Turkey RoHS compliance



■ Türkiye Cumhuriyeti: AEEE Yönetmeliğine Uygundur.

[Republic of Turkey: In conformity with the WEEE Regulation]

Disposal of batteries in the product



This product contains batteries covered by the Directive 2006/66/EC which must be collected and disposed of separately from municipal waste.

If the battery contains more than the specified values of lead (Pb), mercury (Hg) or cadmium (Cd), these chemical symbols will appear below the crossed-out wheeled bin symbol.

By participating in separate collection of batteries, you will help to ensure proper disposal and to prevent potential negative effects on the environment and human health.

Guarantee and Compensation

Barco provides a guarantee relating to perfect manufacturing as part of the legally stipulated terms of guarantee. On receipt, the purchaser must immediately inspect all delivered goods for damage incurred during transport, as well as for material and manufacturing faults Barco must be informed immediately in writing of any complaints.

The period of guarantee begins on the date of transfer of risks, in the case of special systems and software on the date of commissioning, at latest 30 days after the transfer of risks. In the event of justified notice of complaint, Barco can repair the fault or provide a replacement at its own discretion within an appropriate period. If this measure proves to be impossible or unsuccessful, the purchaser can demand a reduction in the purchase price or cancellation of the contract. All other claims, in particular those relating to compensation for direct or indirect damage, and also damage attributed to the operation of software as well as to other services provided by Barco, being a component of the system or independent service, will be deemed invalid provided the damage is not proven to be attributed to the absence of properties guaranteed in writing or due to the intent or gross negligence or part of Barco.

If the purchaser or a third party carries out modifications or repairs on goods delivered by Barco, or if the goods are handled incorrectly, in particular if the systems are operated incorrectly or if, after the transfer of risks, the goods are subject to influences not agreed upon in the contract, all guarantee claims of the purchaser will be rendered invalid. Not included in the guarantee coverage are system failures which are attributed to programs or special electronic circuitry provided by the purchaser, e.g. interfaces. Normal wear as well as normal maintenance are not subject to the guarantee provided by Barco either.

The environmental conditions as well as the servicing and maintenance regulations specified in this manual must be complied with by the customer.

Copyright ©

All rights reserved. No part of this document may be copied, reproduced or translated. It shall not otherwise be recorded, transmitted or stored in a retrieval system without the prior written consent of Barco.

Software License Agreement

You should carefully read the following terms and conditions before using this software. Your use of this software indicates your acceptance of this license agreement and warranty.

Terms and Conditions:

1. No redistribution of the software is allowed.
2. Reverse-Engineering. You may not reverse engineer, decompile, disassemble or alter this software product.

Disclaimer of Warranty:

This software and the accompanying files are sold "as is" and without warranties as to performance or merchantability or any other warranties whether expressed or implied. In no event shall Barco be liable for damage of any kind, loss of data, loss of profits, business interruption or other pecuniary loss arising directly or indirectly. Any liability of the seller will be exclusively limited to replacement of the product or refund of purchase price.

Patent protection

Please refer to www.barco.com/about-barco/legal/patents

Table of contents

1	Safety and environment information	9
1.1	General considerations	10
1.2	Important safety instructions	11
1.3	Safety symbols Bragi	14
1.4	Location of labels	15
1.5	Disposal information	16
1.6	Turkey RoHS compliance	17
1.7	China RoHS compliance	18
1.8	Taiwan RoHS compliance	20
1.9	Contact information	21
1.10	Production Address	22
1.11	Product Info	23
1.12	Statement	24
2	Lenses	25
2.1	Approved lenses	26
2.2	Replace a lens	27
2.3	Locking the lens position	29
3	Physical installation	31
3.1	Installation process	32
3.2	Installation conditions	33
3.3	Initial inspection	35
3.4	Positioning the projector	36
3.5	Mounting the projector, general considerations	37
3.6	Mounting surfaces	38
3.7	Projector safe attachment points	39
3.8	Removal of the front cover	41
3.9	Throw distance	42
3.10	Scheimpflug (Boresight) adjustment	45
3.11	Scheimpflug adjustment procedure	46
4	Getting the projector started	49
4.1	Projector source and control connections	50
4.1.1	Input source connections	50
4.1.2	Connector Specifications	50
4.1.2.1	DVI-I	50

4.1.2.2	Display Port 1.2	51
4.1.2.3	HDMI 2.0	52
4.1.2.4	HDBase T	53
4.1.3	Control Interfaces.....	53
4.1.3.1	RS-232	54
4.1.3.2	LAN/Ethernet.....	55
4.1.3.3	USB-A port.....	56
4.2	Power up the projector	57
4.3	Power down the projector	58
4.4	Power mode transitions	59
4.4.1	General	59
4.4.2	Power on projector	60
4.4.3	Going from READY to ON.....	61
4.4.4	Going from ON to READY.....	62
4.4.5	Going from READY to ECO standby.....	63
4.4.6	Going from ECO to ON	64
4.4.7	Wake On LAN (WOL)	65
4.5	Power modes	66
4.6	Customize projector settings	67
4.7	User interface.....	68
4.7.1	On Screen Display (OSD).....	68
5	Source menu.....	69
5.1	Connector selection.....	70
5.2	Connector settings	71
5.3	Using dual inputs.....	74
6	Image menu.....	75
6.1	Contrast.....	77
6.2	Brightness	78
6.3	Saturation	79
6.4	Sharpness.....	80
6.5	Gamma adjustment	81
6.6	Gamma Types	82
6.6.1	Predefined Gamma types	82
6.7	Digital Zoom Shift.....	83
6.7.1	Digital Zoom	83
6.7.2	Digital Shift.....	85
6.8	Advanced image adjustments	86
6.8.1	P7 Realcolor	86
6.8.2	Edit the RealColor presets.....	87
6.8.3	Output resolution 4K.....	89
6.8.4	Brilliant color	90
6.8.5	Displaying HDR content– Perceptual Quantizer (PQ).....	91
6.8.6	HDR PQ tone mapping (Light).....	92
6.8.7	HDR Status.	93
6.8.8	Color Primaries.....	94
6.8.9	Night vision	95
7	Advanced picture adjustments	97
7.1	Cropping the image	98
7.2	Preset Crop mode	99
7.3	Manual Cropping.....	100
7.4	Automatic source cropping.....	101

7.5	Graphic content in autocropping mode	102
7.6	16:9 to center function	103
8	Installation menu	105
8.1	Lens	106
8.1.1	Zoom / Focus	106
8.1.2	Shift	107
8.1.3	Shift to center	108
8.2	Orientation	109
8.3	Scaling modes	110
8.4	Warping	113
8.4.1	About warping	113
8.4.2	Warping – On/Off	113
8.4.3	Warping – Screen size	115
8.4.4	Warp – 4 Corners adjustment	117
8.4.5	Warping – Bow	119
8.4.6	Warping – Warp files	123
8.4.7	Warping – Latency control in a multi projector setup	125
8.5	Blending	127
8.5.1	Introduction to blend functions	127
8.5.2	Set up the system	128
8.5.3	Blend mask setup procedure	128
8.5.4	Basic blend setup procedure	130
8.5.5	Black level setup procedure	132
8.5.6	Color level adjustment procedure	134
8.5.7	Black level files	135
8.5.8	Blend files	136
8.5.9	Advanced blend	137
8.5.10	CLO — Constant light output	138
8.6	IG pixel shift	139
8.6.1	IG pixel shift	139
8.6.2	AutoStereo (3D) Setup	140
9	GUI – Profiles	141
9.1	Profiles introduction	142
9.2	Profiles setup parameters	143
9.3	Create new profile	145
10	System settings menu	149
10.1	Communication	150
10.2	IR control	151
10.2.1	Broadcast address	151
10.2.2	Projector address	152
10.2.3	IR sensors	153
10.3	Setting a custom projector name	154
10.4	Trigger	155
10.5	Language	156
10.6	Themes	157
10.7	Units	158
10.8	Backlight	159
10.9	Power settings	160
10.10	Lens features	161
10.11	Maintenance	162
10.12	Lens calibration	163

10.13	Controlling the backlight of the LCD Display	164
11	GUI – Status menu	165
11.1	Status menu overview	166
12	3D	169
	Index	171

Safety and environment information

1

About

Read this chapter thoroughly before attempting to install or operate the projector.

To prevent personal injury to users or physical damage to the projector while installing and using your projector, ensure that you understand and follow all safety guidelines, instructions and warnings included in this chapter and this manual.

Clarification of the term Bragi series used in this document

Use in this document of the term, Bragi , means that the content is applicable for the following products:

- Bragi CS

Defining the Bragi platform

The Bragi series products in general, are all products within the Barco GP5 platform

1.1 General considerations

Notice on optical radiation from the Bragi projectors

- Do not stare into Beam.
- This projector is Risk Group 2 (RG2) according to IEC EN 62471-5.
- Any operation or adjustment not specifically instructed by the user's guide creates the risk of hazardous light radiation exposure.
- Do not open or disassemble the projector as this may cause danger to unauthorized personnel

General safety instructions

- This product contains no user serviceable parts.
Attempts to modify/replace mechanics or electronics inside the housing or compartments will violate any warranties and may be hazardous.
- Do not stare into beam when the projector is on. The bright light may result in permanent eye damage.
- Before operating this equipment please read this manual thoroughly and retain it for future reference.
- Installation and preliminary adjustments should be performed by properly trained and qualified personnel.
- All warnings on the projector and in the documentation manuals must be adhered to.
- All instructions for operating and use of this equipment must be followed precisely.
- All local installation codes should be adhered to.

Notice on safety

This equipment is built in accordance with the requirements of the international safety standards IEC60950-1, as basis for National safety regulation world wide. The safety standard covers information technology equipment including electrical business equipment intended to operate in "normal" environments (offices and homes). This safety standard imposes important requirements on the use of safety critical components, materials and insulation, in order to protect the user or operator against risk of electric shock and energy hazard and having access to live parts. Safety standards also impose limits to the internal and external temperature rises, radiation levels, mechanical stability and strength, enclosure construction and protection against the risk of fire. Simulated single fault condition testing reduce the risk of hazards and contribute to ensure the safety of the equipment to the user even when the equipment's normal operation fails.

Users definition

Throughout this manual, the term SERVICE PERSONNEL refers to Barco authorized persons having appropriate technical training and experience necessary to be knowledgeable of potential hazards to which they are exposed (including, but not limited to HIGH VOLTAGE ELECTRIC and ELECTRONIC CIRCUITRY and HIGH BRIGHTNESS PROJECTORS) in performing a task, and of measures to minimize the potential risk to themselves or other persons. Only Barco authorized SERVICE PERSONNEL, knowledgeable of such risks, are allowed to perform service functions inside the product enclosure. The term USER and OPERATOR refers to any person other than SERVICE PERSONNEL.

1.2 Important safety instructions

To prevent the risk of electrical shock

- This product should be operated from a mono phase AC power source.
- This apparatus must be grounded (earthed) via the supplied 3 conductor AC power cable. If none of the supplied power cables are the correct one, consult your dealer.
If you are unable to insert the plug into the outlet, contact your electrician to replace your obsolete outlet. Do not defeat the purpose of the grounding-type plug.
Never use 2- wire power cords, as this is dangerous and could lead to electrical shock. Always use a power connector with a ground terminal.
- Do not allow anything to rest on the power cord. Do not locate this product where persons will walk on the cord. To disconnect the cord, pull it out by the plug. Never pull the cord itself.
- Ensure that the main power cord complies with the national regulations at the site where the equipment is used.
- Do not use unauthorized replacements
- Do not operate the projector with a damaged cord. Replace the cord.
Do not operate the projector if the projector has been dropped or damaged - until it has been examined and approved for operation by a qualified service technician.
- Position the cord so that it will not be tripped over, pulled, or contact hot surfaces.
- If an extension cord is necessary, a cord with a current rating at least equal to that of the projector should be used. A cord rated for less amperage than the projector may overheat.
- Never push objects of any kind into this product through cabinet slots as they may touch dangerous voltage points or short out parts that could result in a risk of fire or electrical shock.
- Make sure that no objects enter into the vents and openings of the set.
- Do not expose this projector to rain or moisture.
- The projector is designed for indoor use only. Never operate the unit outdoors.
- Do not immerse or expose this projector in water or other liquids.
- Do not spill liquid of any kind on this projector.
- Should any liquid or solid object fall into the cabinet, unplug the set and have it checked by qualified service personnel before resuming operations.
- Do not disassemble this projector, always take it to an authorized trained service person when service or repair work is required.
- Do not use an accessory attachment which is not recommended by the manufacturer.
- Lightning - For added protection for this video product during a lightning storm, or when it is left unattended and unused for long periods of time, unplug it from the wall outlet. This will prevent damage to the device due to lightning and AC power-line surges.

To prevent personal injury

- To prevent injury and physical damage, always read this manual and all labels on the system before connecting to the wall outlet or adjusting the projector.
- To prevent injury, take note of the weight of the projector.
- To prevent injury, ensure that the lens and all covers are correctly installed. See installation procedures.
- Warning: high intensity light beam. NEVER look into the lens! High luminance could result in damage to the eye.
- Always switch off the projector and disconnect from the mains power supply before attempting to remove any of the projector covers or access parts inside the projector.
- This product contains no user serviceable parts. Attempts to modify/replace mechanics or electronics inside the housing or compartments will violate any warranties and may be hazardous.
- Do not place this equipment on an unstable cart, stand, or table. The product may fall, causing serious damage to it and possible injury to the user.
- Only place the projector on a stable surface, or mount it securely using an approved ceiling-mount.

To prevent fire hazard

- Barco projection products are designed and manufactured to meet the most stringent safety regulations. This projector radiates heat on its external surfaces and from ventilation ducts during normal operation, which is both normal and safe. Exposing flammable or combustible materials into close proximity of this projector could result in the spontaneous ignition of that material, resulting in a fire. For this reason, it is

absolutely necessary to leave an “exclusion zone” around all external surfaces of the projector whereby no flammable or combustible materials are present.

- Do not place flammable or combustible materials near the projector!
- Caution! Hot air is exhausted from the rear vent. Do not place objects that are sensitive to heat nearer than 25 cm (10”) to the exhaust vent.
- Slots and openings in this equipment are provided for ventilation. To ensure reliable operation of the projector and to protect it from overheating, these openings must not be blocked or covered.
- The openings should never be blocked by placing the projector too close to walls, or other similar surface. Allow for sufficient distance to walls and ceilings to avoid overheating. Minimum safety distance to the exhaust area of the unit must not be less than 25 cm (10”) and to the intake area, not less than 25 cm (10”).
- This projector should never be placed near or over a radiator or heat register.
- This projector should not be placed in a built-in installation or enclosure unless proper ventilation is provided.
- Do not cover the projector or the lens with any material while the projector is in operation. Keep flammable and combustible materials away from the projector at all times.
- Mount the projector in a well-ventilated area away from sources of ignition and out of direct sun light. Always allow ample airflow through the projector.
- Never expose the projector to rain or moisture. In the event of fire, use sand, CO2 or dry powder fire extinguishers.
- Never use water on an electrical fire.
- Always have service performed on this projector by authorized Barco service personnel. Always insist on genuine Barco replacement parts. Never use non-Barco replacement parts as they may degrade the safety of this projector.
- Projection rooms must be well ventilated or cooled in order to avoid heat buildup.
- Let the projector cool down completely before storing. Remove cord from the projector when storing.

To prevent projector damage

- To ensure correct airflow is maintained, the projector should only be operated when all of its covers in place. The exception from this is the front cover, that can be removed to give access to multiple anchor points. See User Guide for more detailed info regarding this issue.
- Always remove lens cap before switching on the projector. If the lens cap is not removed, it may melt due to the high energy light emitted through the lens. Melting the lens cap may permanently damage the surface of the projection lens
- Only connect the projector to signal sources and voltages as described in the technical specification. Connecting to unspecified signal sources or voltages may lead to malfunction and permanent damage of the unit.
- To ensure correct airflow is maintained, it should only be operated when all of its covers are in place.
- The projector must always be installed in a manner which ensures free flow of air into its air inlets and unimpeded evacuation of the hot air from its cooling system.
- Slots and openings in the cabinet are provided for ventilation. To ensure reliable operation of the product and to protect it from overheating, these openings must not be blocked or covered. The openings should never be blocked by placing the product on a bed, sofa, rug, or other similar surface. This product should never be placed near or over a radiator or heat register. The device should not be placed in a built-in installation or enclosure unless proper ventilation is provided. Ensure that nothing can be spilled on, or dropped inside the projector. If this does happen, switch off and unplug the mains supply immediately. Do not operate the projector again until it has been checked by Barco authorized service personnel.
- Do not block the projector cooling fans or free air movement around the projector. Minimum safety distance to the exhaust area of the unit must not be less than 25 cm (10”) and to the intake area, not less than 25 cm (10”).
- Do not use this equipment near water.
- Do not operate the projector outside its temperature and humidity specifications as this may result in overheating and malfunction.
- Never place the projector in direct sun light. Sun light on the lens can severely damage the Digital Mirror Devices™ in which case there is a loss of warranty.
- Save the original shipping carton and packing material. They will come in handy if you ever have to ship your equipment. For maximum protection, repack your set as it was originally packed at the factory.
- Unplug this product from the wall outlet before cleaning. Do not use liquid cleaners or aerosol cleaners. Use a damp cloth for cleaning. Never use strong solvents, such as thinner or benzene, or abrasive cleaners, since these will damage the cabinet. Stubborn stains may be removed with a cloth lightly dampened with mild detergent solution.





- To ensure the highest optical performance and resolution, the projection lenses are specially treated with an anti-reflective coating, therefore, avoid touching the lens. To remove dust on the lens, use a soft dry cloth. Do not use a damp cloth, detergent solution, or thinner.

On servicing

- Do not attempt to service this product yourself, as opening or removing covers may expose you to dangerous voltage potentials and risk of electric shock.
- Refer all servicing to Barco authorized repair centers.
- Attempts to alter the factory-set internal controls or to change other control settings not specially discussed in this manual can lead to permanent damage to the projector and cancellation of the warranty.
- Unplug this product from the wall outlet and refer servicing to Barco authorized service personnel or technicians under the following conditions:
 - If liquid has been spilled into the equipment.
 - If the product has been exposed to rain or water.
 - If the product does not operate normally when the operating instructions are followed. Adjust only those controls that are covered by the operating instructions since improper adjustment of the other controls may result in damage and will often require extensive work by a qualified technician to restore the product to normal operation.
 - If the product has been dropped or the cabinet has been damaged.
 - If the product exhibits a distinct change in performance, indicating a need for service.
 - When the power cord or plug is damaged or frayed.
- Replacement parts: When replacement parts are required, be sure the service technician has used original Barco replacement parts. Unauthorized substitutions may result in degraded performance and reliability, fire, electric shock or other hazards. Unauthorized substitutions may void warranty.
- Safety check: Upon completion of any service or repairs to this projector, ask the service technician to perform safety checks to determine that the product is in proper operating condition.

1.3 Safety symbols Bragi

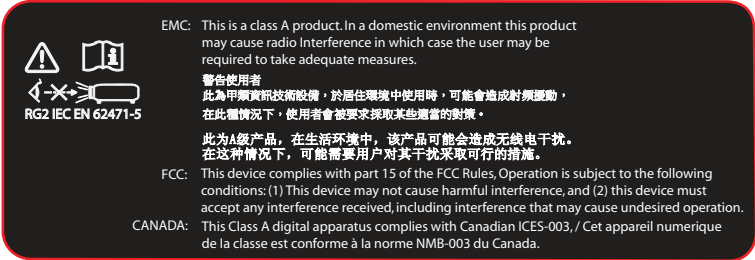
Description of safety symbols used in product documentation or on product.

Image	Description
	<p>Refer to user manual for further information!</p>
	<p>Caution! Do not stare into beam, RG2 product.</p>
	<p>No telephone! Do not connect to telephone lines.</p>
 <p>EMC: This is a class A product. In a domestic environment this product may cause radio Interference in which case the user may be required to take adequate measures.</p> <p>警告使用者 此為甲類資訊技術設備，於居住環境中使用時，可能會造成射頻擾動，在此種情況下，使用者會被要求採取某些適當的對策。</p> <p>此為A級產品，在生活環境中，該產品可能會造成無線電干擾。在這種情況下，可能需要用戶對其干擾採取可行的措施。</p> <p>FCC: This device complies with part 15 of the FCC Rules, Operation is subject to the following conditions: (1) This device may not cause harmful interference, and (2) this device must accept any interference received, including interference that may cause undesired operation.</p> <p>CANADA: This Class A digital apparatus complies with Canadian ICES-003./ Cet appareil numérique de la classe est conforme à la norme NMB-003 du Canada.</p>	<p>EMC Label</p>
 <p>RG2 IEC EN 62471-5</p>	<p>RG2 Label</p>

1.5 Disposal information

Disposal Information

Waste Electrical and Electronic Equipment



■ This symbol on the product indicates that, under the European Directive 2012/19/EU governing waste from electrical and electronic equipment, this product must not be disposed of with other municipal waste. Please dispose of your waste equipment by handing it over to a designated collection point for the recycling of waste electrical and electronic equipment. To prevent possible harm to the environment or human health from uncontrolled waste disposal, please separate these items from other types of waste and recycle them responsibly to promote the sustainable reuse of material resources.

For more information about recycling of this product, please contact your local city office or your municipal waste disposal service.

For details, please visit the Barco website at: <http://www.barco.com/AboutBarco/weee>

WEEE Information

This product conforms to all requirements of the EU Directive on waste electrical and electronic equipment (WEEE). This product shall be recycled properly. It can be disassembled to facilitate proper recycling of its individual parts.

Consult your dealer or relevant public authority regarding drop-off points for collection of WEEE. For details, please visit the Barco website at: <http://www.barco.com/en/AboutBarco/weee>.

1.6 Turkey RoHS compliance

Turkey RoHS compliance



■ Türkiye Cumhuriyeti: AEEE Yönetmeliğine Uygundur.
[Republic of Turkey: In conformity with the WEEE Regulation]

1.7 China RoHS compliance

中国大陆 RoHS (Information for China ROHS compliance)

根据中国大陆《电器电子产品有害物质限制使用管理办法》（也称为中国大陆RoHS），以下部分列出了Barco产品中可能包含的有毒和/或有害物质的名称和含量。中国大陆RoHS指令包含在中国信息产业部MCV标准：“电子信息产品中有毒物质的限量要求”中。

According to the “Management Methods for the Restriction of the Use of Hazardous Substances in Electrical and Electronic Products” (Also called RoHS of Chinese Mainland), the table below lists the names and contents of toxic and/or hazardous substances that Barco’s product may contain. The RoHS of Chinese Mainland is included in the MCV standard of the Ministry of Information Industry of China, in the section “Limit Requirements of toxic substances in Electronic Information Products”.

零件项目(名称) Component name	有毒有害物质或元素 Hazardous substances and elements					
	铅 (Pb)	汞 (Hg)	镉 (Cd)	六价铬 (Cr6+)	多溴联苯 (PBB)	多溴二苯醚 (PBDE)
印制电路配件 Printed Circuit Assemblies	X	O	X	O	O	O
外接电(线)缆 External Cables	X	O	O	O	O	O
内部线路 Internal wiring	X	O	O	O	O	O
镜头支架 Lensholder	X	O	O	O	O	O
螺帽,螺钉(栓),螺旋(钉),垫圈, 紧固件 Nuts, bolts, screws, washers, Fasteners	X	O	O	O	O	O
电源供应器 Power Supply Unit	X	O	O	O	O	O
风扇 Fan	X	O	O	O	O	O
附電池遙控器 Remote control	X	O	O	O	O	O

本表格依据SJ/T 11364的规定编制

This table is prepared in accordance with the provisions of SJ/T 11364.

O: 表示该有毒有害物质在该部件所有均质材料中的含量均在 GB/T 26572 标准规定的限量要求以下。

O: Indicates that this toxic or hazardous substance contained in all of the homogeneous materials for this part is below the limit requirement in GB/T 26572.

X: 表示该有毒有害物质至少在该部件的某一均质材料中的含量超出 GB/T 26572 标准规定的限量要求。

X: Indicates that this toxic or hazardous substance contained in at least one of the homogeneous materials used for this part is above the limit requirement in GB/T 26572.



在中国大陆销售的相应电子信息产品（EIP）都必须遵照中国大陆《电子电气产品有害物质限制使用标识要求》标准贴上环保使用期限（EFUP）标签。Barco产品所采用的EFUP标签（请参阅实例，徽标内部的编号使用于指定产品）基于中国大陆的《电子信息产品环保使用期限通则》标准。

All Electronic Information Products (EIP) that are sold within Chinese Mainland must comply with the “Marking for the restriction of the use of hazardous substances in electrical and electronic product” of Chinese Mainland, marked with the Environmental Friendly Use Period (EFUP) logo. The number inside the EFUP logo that Barco uses (please refer to the photo) is based on the “General guidelines of environment-friendly use period of electronic information products” of Chinese Mainland.

1.8 Taiwan RoHS compliance

限用物質含有情況標示聲明書 (Declaration of the Presence Condition of the Restricted Substances Marking)

單元 Unit	限用物質及其化學符號 Restricted substances and its chemical symbols					
	鉛 Lead (Pb)	汞 Mercury (Hg)	鎘 Cadmium (Cd)	六價鉻 Hexavalent chromium (Cr6+)	多溴聯苯 Polybrominated biphenyls (PBB)	多溴二苯醚 Polybrominated diphenyl ethers (PBDE)
印製電路板配件 Printed Circuit Assemblies	—	○	—	○	○	○
外接電 (線) 纜 External Cables	—	○	○	○	○	○
內部線路 Internal wiring	—	○	○	○	○	○
鏡頭支架 Lensholder	—	○	○	○	○	○
螺絲組件 Nuts, bolts, screws, washers, Fasteners	—	○	○	○	○	○
電源供應器 Power Supply Unit	—	○	○	○	○	○
風扇 Fan	—	○	○	○	○	○
遙控器 Remote control	—	○	○	○	○	○
<p>備考1. “超出0.1 wt %” 及 “超出0.01 wt %” 係指限用物質之百分比含量超出百分比含量基準值。 Note 1 : “Exceeding 0.1 wt %” and “exceeding 0.01 wt %” indicate that the percentage content of the restricted substance exceeds the reference percentage value of presence condition.</p> <p>備考2. “○” 係指該項限用物質之百分比含量未超出百分比含量基準值。 Note 2 : “○” indicates that the percentage content of the restricted substance does not exceed the percentage of reference value of presence.</p> <p>備考3. “—” 係指該項限用物質為排除項目。 Note 3 : The “—” indicates that the restricted substance corresponds to the exemption.</p>						

備註: 此RoHS表格適用於以下產品型號: GP5

Hint: This RoHS table is suitable for following models: GP5

1.9 Contact information

Barco contact information

Registered office address: President Kennedypark 35, 8500 Kortrijk, Belgium

Contact address: Beneluxpark 21, 8500 Kortrijk, Belgium

Contact address (for Taiwan) :

公司名稱 (Company Name) : 巴可股份有限公司

地址 (Address) : 新北市板橋區新站路16號33樓

傳真 (Fax) : 02-7715 0298

電話 (Tel) : 02-7715 0299

E-mail : service.taiwan@barco.com

Importers contact information

To find your local importer, contact Barco directly or one of Barco's regional offices via the contact information given on Barco's web site, www.barco.com.

Contact information Norway factory

Barco Fredrikstad as

Habornveien 53, N1630 Gamle Fredrikstad, Norway

Phone: +476930 4550

Support:Support.fre@barco.com

1.10 Production Address

Factories

Barco NV (BELGIUM)

President Kennedypark 35 , B-8500 Kortrijk

1.11 Product Info

Product info

BARCO

Image 1-2

product name 產品名稱:

projector 投影機

model 型號: GP5

1.12 Statement

EN55032/CISPR32 Class A MME (MultiMedia Equipment)

Warning : This equipment is compliant with Class A of CISPR 32. In a residential environment this equipment may cause radio interference.

Class A ITE (Information Technology Equipment)

Warning : This is a class A product. In a domestic environment this product may cause radio interference in which case the user may be required to take adequate measures.

警告使用者: 此為甲類資訊技術設備，於居住環境中使用時，可能會造成射頻擾動，在此種情況下，使用者會被要求採取某些適當的對策。

Lenses

2

2.1	Approved lenses.....	26
2.2	Replace a lens	27
2.3	Locking the lens position	29

2.1 Approved lenses

Approved lenses

This table contains the lenses that are within the certification of the projector.

Partnumber	Lens Name	Description (WQXGA)
R9801211	EN44	FLD+ 2.5 - 4.6 : 1
R9801220	EN45	FLD+ Long Focus 0.8 - 1.21 : 1
R9801295	EN47	FLD+ 0.65 : 1
R9802241	EN61	FLDX 1.7- 2.5: 1
R9802242	EN63	FLDX 1.2 - 1.7 : 1
R9802243	EN66	FLDX 0.8 - 1.21 : 1
R9802232	EN68	FLD+ 0.28:1
R9802010	EN62	FLDX 0.8:1
R9802003	EN76	FLDX 0.9:1.3



Lenses other than above listed may also be used, but the maximum throw ratio will be limited to 7:1.
All lenses up to 7:1 belong to RG2.

2.2 Replace a lens

Lens lever

The L40 lens mount and lens lever is designed to prevent damage to the lens board while providing an easy and stable lens change procedure.

The lens lever, located at the bottom of the lens mount, slides between two positions, far left (default position — unlocked) and far right (locked).



Always activate the projector shutter before attempting to remove or install a lens.

To do this, press the **shutter** button on the keypad, or shutter Close on the remote, to activate the shutter. The keypad button will illuminate red when the shutter is activated.

Press the **shutter** button again, or shutter Open on the remote, to deactivate the shutter and resume normal operation. The keypad button will illuminate white when the shutter is deactivated.



When changing from a lens with motorized Iris, zoom and focus positioning functionality, to a lens without this functionality (e.g. from a EN 63 to a EN42 lens), it is recommended to power down, and pull the AC cord. This is because the memory of the iris position will not be reset, but will show the position in LCD or OSD for the lens that was removed. When rebooting the projector, the memory will be reset.

The reverse scenario will happen when changing from a lens with no motorized positioning support, to a lens with motorized positioning support. The iris position will not be showed with a correct value. The functionality is still present, but the displayed value is not correct.

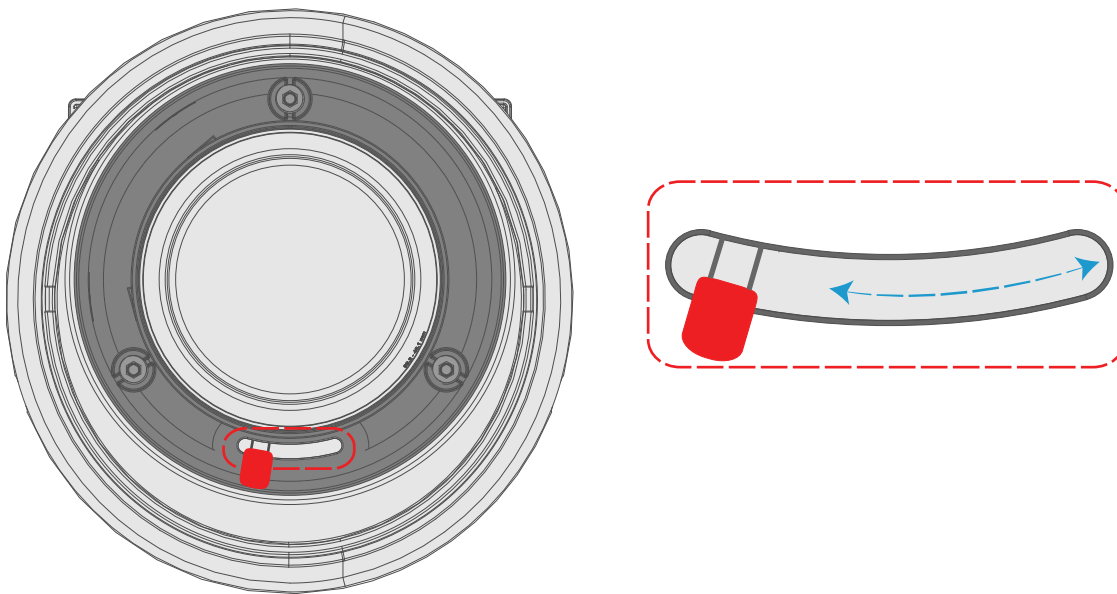

Image 2-1

Install a lens

1. Verify that the projector shutter is activated (shutter is activated when the shutter icon on the projector keypad is red).
2. Verify that the lens release lever is in its default position at the far left of the slide, as illustrated.
3. Remove the protective cap at the lens bayonet end
4. Align the lens so that the red marking on the bayonet is facing upwards.
5. Position the lens bayonet into the projector lens mount and support in place with one hand.
6. Slide the lens lever to the far right.

7. Verify that the lens is firmly in place before removing your hand from the lens.

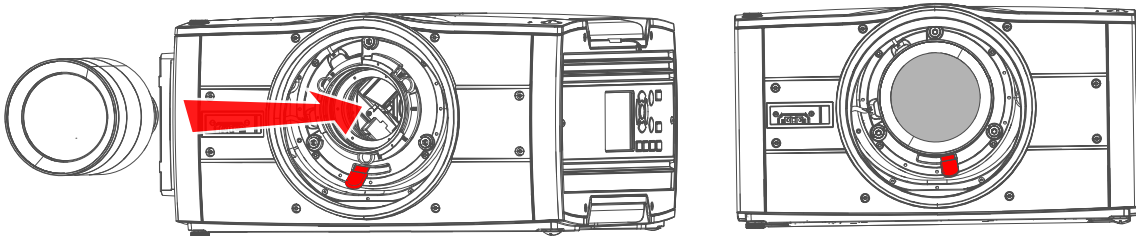

Image 2-2

Remove a lens

1. Support the lens with one hand.
2. Use the other hand to slide the lens release lever to the far left position.
3. Pull the lens straight out of the projector lens mount.
4. Replace with another lens, or install the projector lens cap.

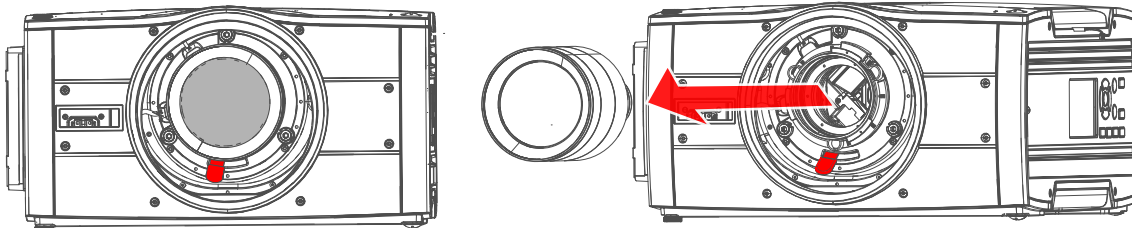

Image 2-3

2.3 Locking the lens position

About

The projector has the feature of mechanically lock the lens position in both horizontal and vertical position.

This is particularly important in moving platform applications in order to avoid that the lens comes out of position during operation. This topic describes the procedure for this operation.

CAUTION:



It is of great importance to disable the Lens Shift function when the mechanically lens lock is performed. If not, the shift mechanism will be possible destroyed if lens shift accidentally is performed from the remote control, keypad, and also via API command, when the mechanism is mechanically locked.

Tools needed

- Screwdriver Tx25
- Wrench or Socket wrench 8mm, OR allen key 4mm

Lens lock screw

The lens lock screws has a special design that allows use of two different tools for tightening; 4mm Allen key or 8mm wrench.

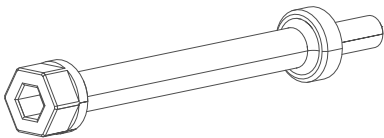

Image 2-4 Lens lock screw



Maximum tightening torque: 2.0 Nm.

Lens lock procedure.

1. Move the lens to the optimal horizontal and vertical position.
2. Disable the lens shift function by entering the menu *Home / System Settings / Service / Lens features*. Select the function to disable by the arrow keys, and disable the function by pressing the OK button.

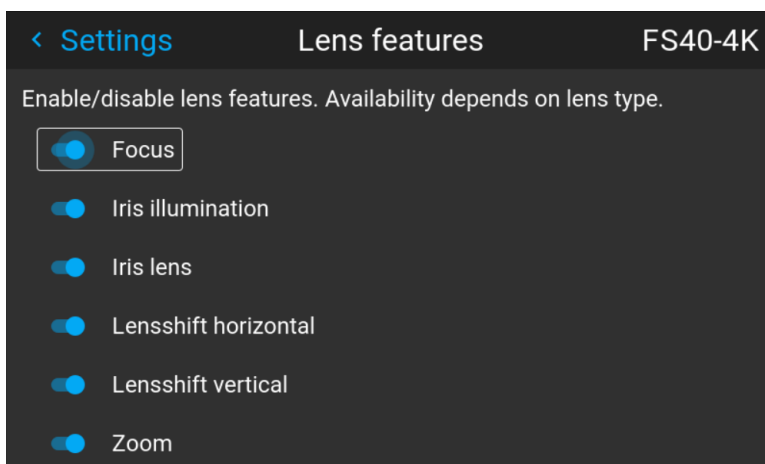

Image 2-5

3. Release 8 screws in front of the projector indicated in the figure below.
Remove the front cover

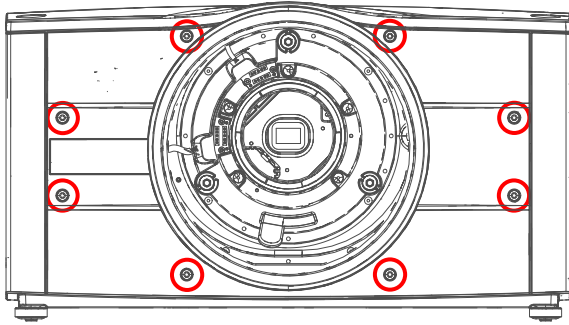

Image 2-6

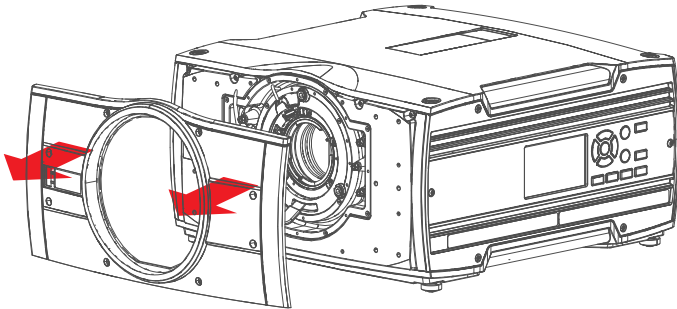

Image 2-7

4. Tighten the screws indicated below.

Tighten the screws indicated by the **red** circles for locking the **vertical** movement

Tighten the screws indicated by the **blue** circles for locking the **horizontal** movement

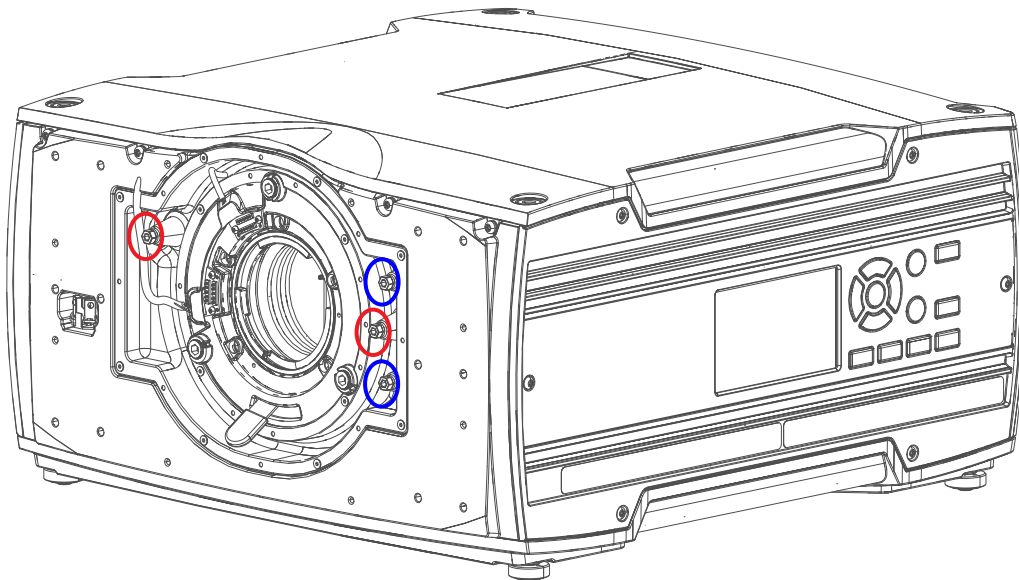

Image 2-8

5. Reassemble the front cover.

Physical installation

3

3.1	Installation process	32
3.2	Installation conditions.....	33
3.3	Initial inspection.....	35
3.4	Positioning the projector.....	36
3.5	Mounting the projector, general considerations	37
3.6	Mounting surfaces	38
3.7	Projector safe attachment points.....	39
3.8	Removal of the front cover.....	41
3.9	Throw distance.....	42
3.10	Scheimpflug (Boresight) adjustment.....	45
3.11	Scheimpflug adjustment procedure	46

About

This chapter describes the physical conditions and procedures required when installing the projector. It also describes the outlines and some of the considerations that should be taken in to account when designing and setting up the installation.

Each projector installation is unique, and as such the information in this chapter is only provided as a guideline. Likewise, any images or graphical representations shown here are for illustrative purposes only.

If you require further information and assistance during the installation process, contact a qualified projection technician or your local support office for advice.

CAUTION:



When the projector is installed in a motion platform setup, an additional lens support must be applied, in order to stabilize the lens, and prevent it from separate from the projector and cause damage to equipment and personnel.

This lens support must be adapted to the actual installation. There is no standard solution from Barco available for this purpose.

It is the responsibility of the installer to ensure that the additional lens fixture is approved.

3.1 Installation process

Recommended Installation sequence

Item	Procedure
1	Confirm that the installation area meets all technical and environmental requirements
2	Decide where the projector will be mounted
3	Unpack the projector and confirm that all equipment is present and in good working order
4	Mount the projector
5	Install the projector lens
6	Connect the source
7	Power up the projector
8	Set up the image

3.2 Installation conditions

Environmental Conditions



Barco projectors are manufactured according to specific design standards, which also include environmental conditions. Failing to follow the terms and conditions outlined in this chapter can result in loss of product warranty

The table below summarize the physical environments in which the projector may be safely operated or stored.

Environment	Ambient operating temperature	Relative Humidity	Storage condition
0 -1500m	+10 to +40 °C	10 –80% RH	–20 to +60 °C, 10 – 90 % RH
1500 -3000m	+10 to +35 °C	10 –80% RH	–20 to +60 °C, 10 – 90 % RH
Maximum Air Flow	400m ³ /hour	10 –80% RH	Not Applicable



For PRC (People's Republic of China) the certified altitude is specified on the product label.

Mains power requirement

Projector	Power Requirement
Projectors, all in range	100 –240V. 60 –50 Hz.

To protect operating personnel, the National Electrical Manufacturers Association (NEMA) recommends that the instrument panel and cabinet be grounded.

In no event shall this projector be operated without an adequate cabinet ground connection.

The AC supply must be installed by a qualified electrician in conformance to local codes. Hardware, wire sizes and conduit types must comply with local codes.

Ventilation



To ensure that correct airflow is maintained, the projector must only operated when all the covers are in place. The only exception is the front cover, see “Projector safe attachment points”.

The free space necessary between the air intake and exhaust are shown below.

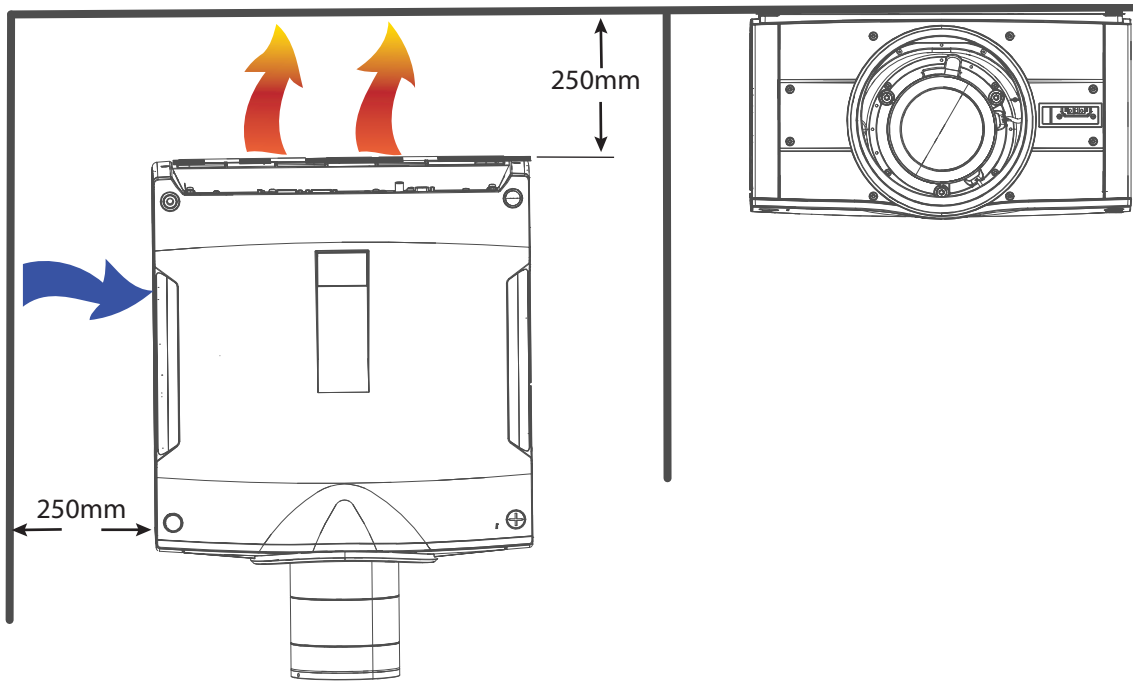

Image 3-1

3.3 Initial inspection

General

Each projector is inspected and rigorously tested at our production facility to ensure that it is free from any mechanical or electrical defects.

Upon receipt of the projector, we recommend that customers inspect the projector for any signs of damage that may have occurred in transit. If damage is found, file a claim with the shipping carrier immediately. Notify the Barco Sales and Service office, or your preferred Barco agent, of the damage as soon as possible.

Box Contents

Your projector box should contain the following:

- Projector unit
- Power cord. (Not all power cords are supplied, see note below).
- Quick start guide
- Safety manual
- Remote Control



If the power cord for your region is not supplied, ensure that the power cord that will be used is according to the regulations for your region. The power cord must be of 3 lead type, where one of the leads is ground. See also the Safety and Environment Information, chapter 1.2 in this document.



The projector lens is delivered in a separate box.

3.4 Positioning the projector



CAUTION: The position and physical securing of the projector must be sufficient to prevent it from accidental or involuntary movement. Proper securing of the projector is the responsibility of the installer and user. The Projector are heavy, and can cause severe damage and injuries if falling.

General guidelines

Proper positioning of the projector lessens the overall picture setup time, and ensures a better image with fewer artifacts.



Focus and sharpness of the image can be adversely affected if the lens axis is not fully perpendicular to the projection surface.



Using extended cable lengths may result in reduced image quality as well as loss of control information such as EDID (Extended Display Information Data).

The following guidelines can help you determine the best physical location for the projector.

- Only install the projector on a sturdy flat surface, or in an approved rigging frame.
- Do not install the projector in a thoroughfare or another area where it is at risk of being pushed or jostled.
- Allow sufficient free space around the projector for ventilation and exhaust, as described in section 4.2
- Use the throw ratio of the installed lens as a guideline for the projector's physical distance from the screen.
- Wherever possible, the projector lens surface should be positioned so that it is perfectly perpendicular to the center of the screen.
Use the projector offset (lens shift), rather than physical angling, to correct any off-center positioning.
- Minimize the source cable length as much as possible.
DP, HDMI and DVI are short-haul interfaces using pre-assembled cables with limited cable lengths.
- Limit the use of power cable extensions wherever possible. Where physical limitations necessitate their use, make sure that the extension cord has adequate surge protection and meets all electrical requirements of the connection.
- Keep the projector away from equipment that emits electromagnetic energy for example, motors, transformers and elevators.

3.5 Mounting the projector, general considerations

Mounting safety

When mounting a projector in a rig, always use an interface plate (between the projector and the mount) that has provision for a safety wire or another safety mechanism, to ensure that the projector does not fall down should the interface plate come loose from the mount.

Always screw the interface plate securely to the projector body while the projector is on the ground (i.e. cannot fall down). Then attach proper safety wire between the interface plate and the rig before mounting the projector in the rig

Using 3rd party mounting equipment

The projector has features for mounting into various system environments using 3rd party mounts See "Projector safe attachment points"..

The feet can be removed and threads can be used for additional mounting points. See table below for dimensions.



Where possible, the projector lens must be positioned exactly perpendicular to the center of the screen. Use the projector offset (lens shift), rather than physical angling, to correct any off-center positioning.



CAUTION: The position and physical securing of the projector must be sufficient to prevent it from accidental or involuntary movement. Proper securing of the projector is the responsibility of the installer and user.



CAUTION: Always use a Rigging Frame when the projector shall be mounted in other ways than on the feet, on a flat surface.

3.6 Mounting surfaces

Mounting on a flat surface

1. Position the projector at the desired location.
2. Power up the projector.
3. Go to *Main Menu / Test Patterns* and select an internal hatch pattern to display on the screen.

Mounting to a ceiling

1. Install the projector in to an approved rigging frame.
2. Install the rigging frame to the desired location.
3. Power up the projector.
4. Go to *Main Menu / Installation / Orientation* and select the correct orientation for your setup.
5. Go to *Main Menu / Test Patterns* and select an internal hatch pattern to display on the screen.
6. Adjust the position (height and angle) of the rigging frame until the projected hatch pattern is a level and perfect rectangle.



If applied in a motion rig, care must be taken to stay within the environmental specifications for vibration and shock.

Contact Barco for more information regarding these specifications.

It may also be necessary to use additional, custom made brackets to stabilize the projection lens to make sure that the projected image remains in position and properly focused.

3.7 Projector safe attachment points

Anchor points bottom plate

Due to use of a Rigging Frame or other equipment, the projector has some defines anchor points that shall be used. See the illustration below.

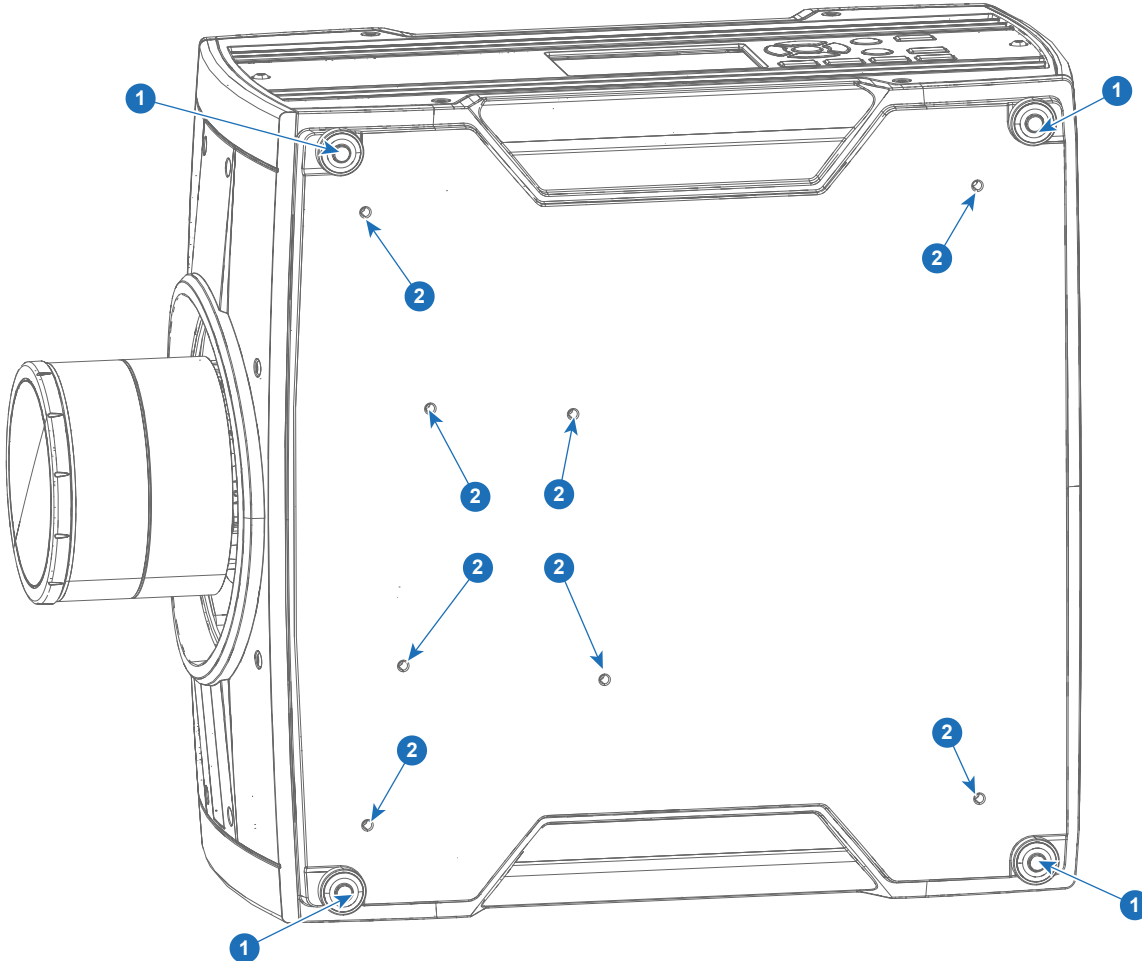

Image 3-2 Bottom anchorpoints

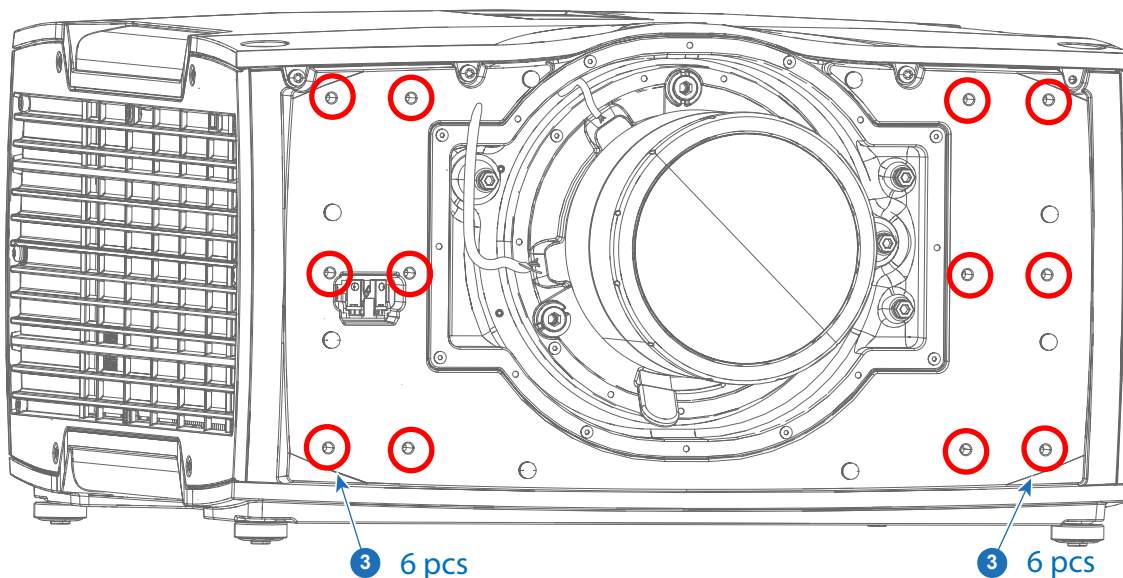

Image 3-3 Front anchorpoints

Item	Thread Dimension	Max Hole Depth	Application
1	M8	15mm	Anchorpoint / Ceiling / Rig Mount
2	M6	10mm	Anchorpoint / Ceiling / Rig Mount
3	M6	10mm	Lens and Blend support (Can also be used a anchorpoints)



WARNING: A minimum of 4 anchor points must be used to secure the projector properly. It is strongly recommended to use fixation points with as long mutually spacing as possible, in order to increase the mechanical stability of the installation.



WARNING: Max tensile load for each anchor point is 43,75 kg. This must be a major consideration when designing the brackets for fixation of the projector.

Anchor points front

There is also 12 anchor points in the front. They will be visible when the plastic front cover is removed. See [“Removal of the front cover”, page 41](#) below, regarding how to remove the front cover.

These anchor points are mainly intended for lens support and other “extras”, but can also be used as anchorpoints.



WARNING: When installing the projector in a motion platform application, the anchor points in front (Item 3 in the illustration and table) must NOT be used. Use the anchor points in the bottom plate for this purpose.

3.8 Removal of the front cover

Required tools

Screwdriver TX20

Procedure

Remove the lens.

Remove the 8 screws, and pull the cover out.

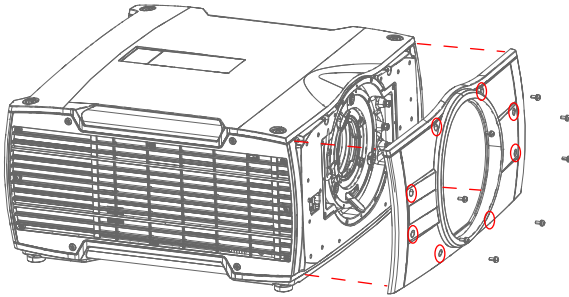

Image 3-4

3.9 Throw distance

Calculate the installation throw distance

Throw is the distance (D) measured from your projector lens to the screen. To calculate the throw distance for an installation, you will need two pieces of data: the selected lens throw ratio (L) and the horizontal width (W) of the screen. For example, if the screen width (W) is 2.4 meters and the projector lens has a throw ratio (L) of 0.99:1, then the throw distance (D) will be 2.38 meters.

Calculation: $2.4 \times 0.99 = 2.38$

The following graphs illustrate the image size (W) and projection distance (D) for each of the projector lenses.



Tolerances are typically +/- 5% due to optical (lens) variation.

Throw distance, FLD WUXGA

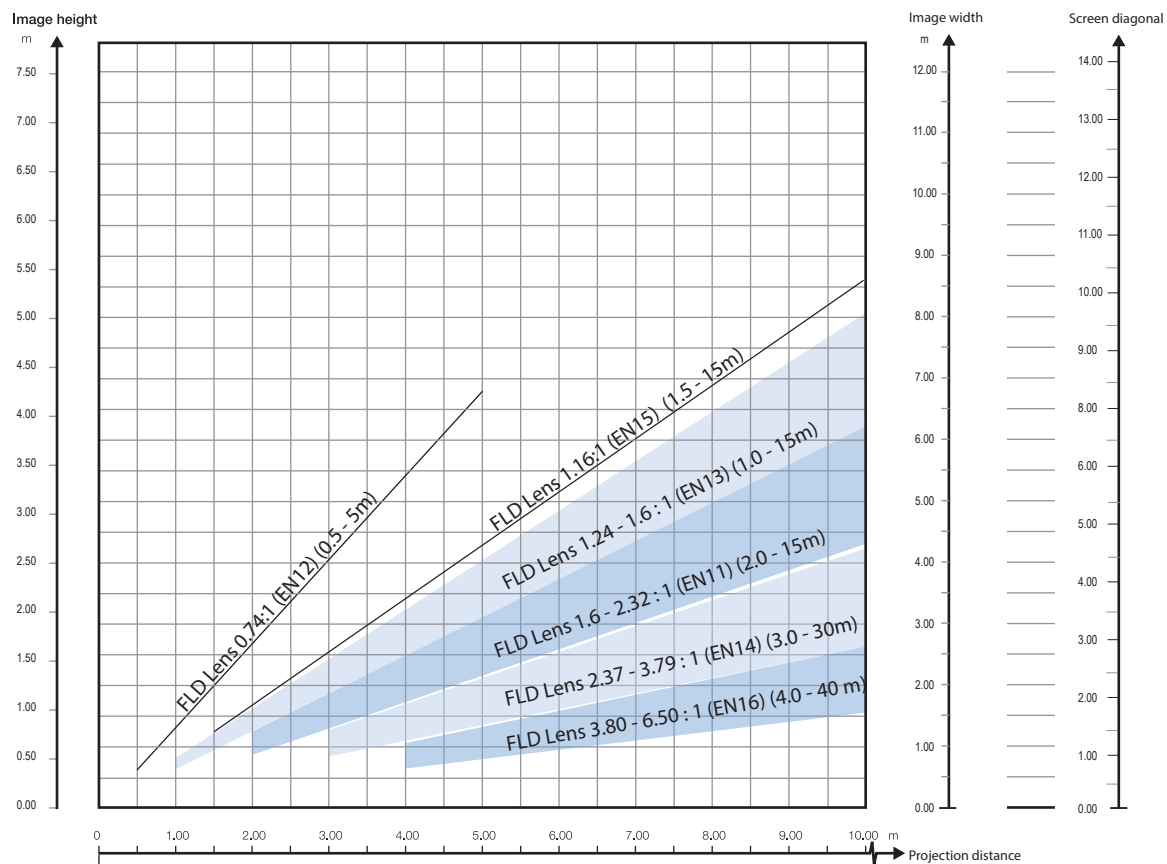

Image 3-5

Throw distance, FLD+ / FLDX WQXGA / 4K UHD

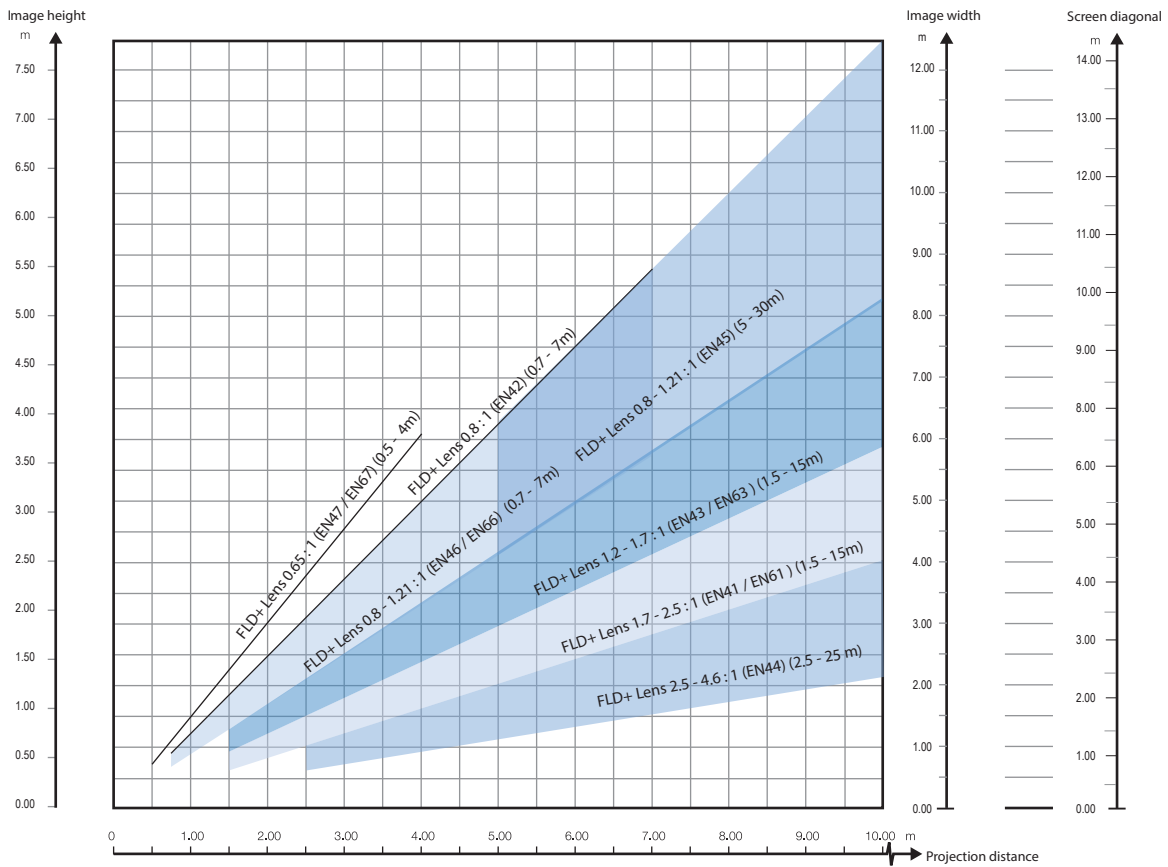

Image 3-6

Throw distance, FLD+ / FLDX WUXGA

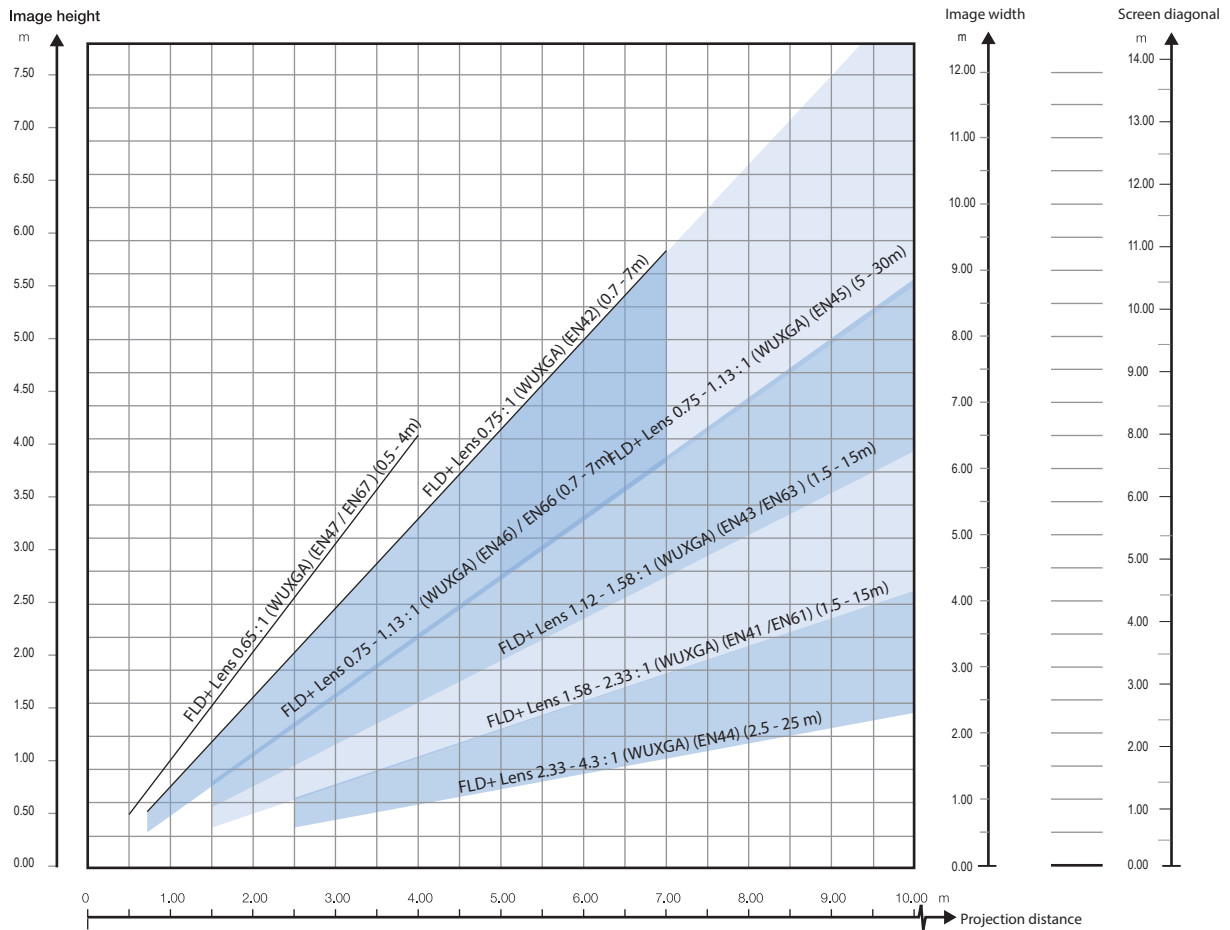

Image 3-7

3.10 Scheimpflug (Boresight) adjustment

What is Scheimpflug?

The lens holder has to be adjusted so that the “sharp focus plane” of the projected image falls together with the plane of the screen (Fp1→Fp2). This is achieved by changing the distance between the DMD plane and the lens plane (Lp1→Lp2). The closer the lens plane comes to the DMD plane the further the sharp focus plane will be. It can occur that you won't be able to get a complete focused image on the screen due to a tilt (or swing) of the lens plane with respect to the DMD plane. This is also known as Scheimpflug's law. To solve this the lens plane must be placed parallel with the DMD plane. This can be achieved by turning the lens holder to remove the tilt (or swing) between lens plane and DMD plane (Lp3→Lp4).

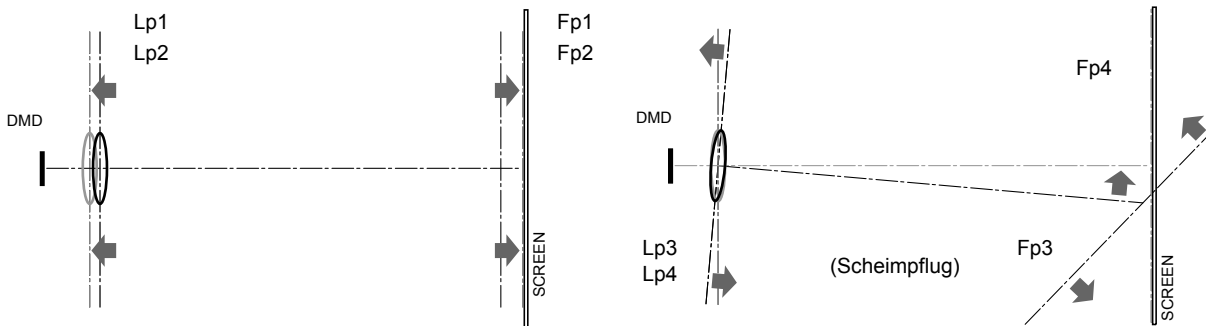

Image 3–8 Scheimpflug principle

Scheimpflug principle



The "plane of sharp focus" can be changed so that any plane can be brought into sharp focus. When the DMD plane and lens plane are parallel, the plane of sharp focus will also be parallel to these two planes. If, however, the lens plane is tilted with respect to the DMD plane, the plane of sharp focus will also be tilted according to geometrical and optical properties. The DMD plane, the principal lens plane and the sharp focus plane will intersect in a line below the projector for downward lens tilt.

Scheimpflug adjustment points

Scheimpflug adjustment points are located on the lens mount. The projector has three (3) set screws and three (3) adjustment screws.

When to apply Scheimpflug?



Scheimpflug correction procedures may only be carried out by suitably trained and experienced technicians.

A Scheimpflug correction should only be applied when the overall focus of the projected image is not equally sharp (for example, if the projector is **NOT in parallel** with the screen or as a result of a previously misaligned Scheimpflug). Be aware that the consequence of applying Scheimpflug correction upon a screen not in parallel with the projector is that the projected image differs from the rectangle shaped image. In other words “**distortion**” of the projected image occurs. **Masking** will be required to solve the distortion.

The disadvantage of Masking is loss of content. Therefore it is **strongly recommended** to place the projector **in parallel** with the projection screen and use the *SHIFT* functionality of the Lens Holder to match the projected image with the projection screen. If the SHIFT range is not sufficient then the projector can be tilted and Scheimpflug can be applied.

3.11 Scheimpflug adjustment procedure



CAUTION: A Scheimpflug adjustment should only be carried out by properly qualified and experienced projection specialists. A poor Scheimpflug adjustment may result in an extremely degraded image and will require factory—servicing to the projector.

Required tools

- Allen key, hex size 4
- Allen key, hex size 6

Preparation

1. Prepare the test area. Barco recommends a projector-screen distance of 2 metres be used for all Scheimpflug adjustments.
Verify that the throw ratio of the installed lens matches the requirements of the installation area (projection distance and screen size).
2. Check that the lens is correctly installed, and lens shift is in centre position.
3. If the installed lens has Iris control, open the Iris all the way up.
4. Open the focus ring all the way up.
5. Go to Main Menu / Test Patterns / Full Screen and select to display the Focus test pattern.
6. Zoom the lens to its widest opening (maximum image size on the screen).

Apply a Scheimpflug correction

1. Loosen the three set screws (reference 1b, 2b, 3b). Use a size 6 hex key to do this.

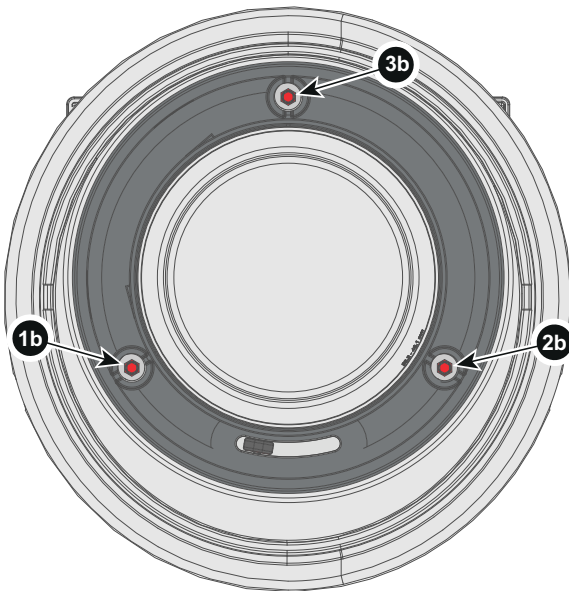

Image 3–9

2. Adjust the left side Scheimpflug adjustment screw (reference 1) until the test image in the top right side of the screen is in focus. Use a size 4 hex key to do this.



Note: This process may cause the other areas of the image to slide out of focus. This is totally normal.

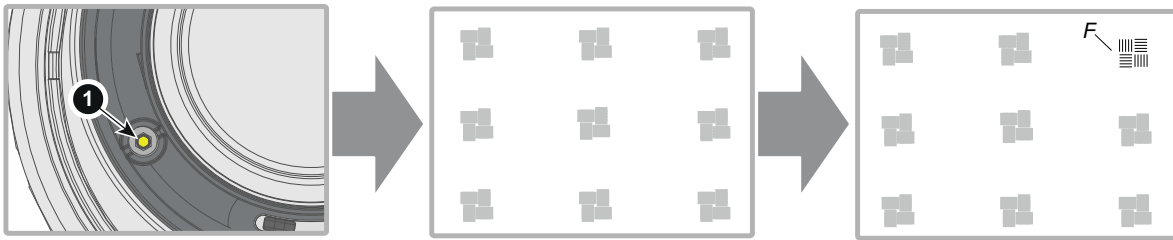



Image 3-10

3. Adjust the right side Scheimpflug adjustment screw (reference 2) until the test image in the top left side of the screen is in focus. Use a size 4 hex key to do this.

 *Note:* This process may cause the other areas of the image to slide out of focus. This is totally normal.

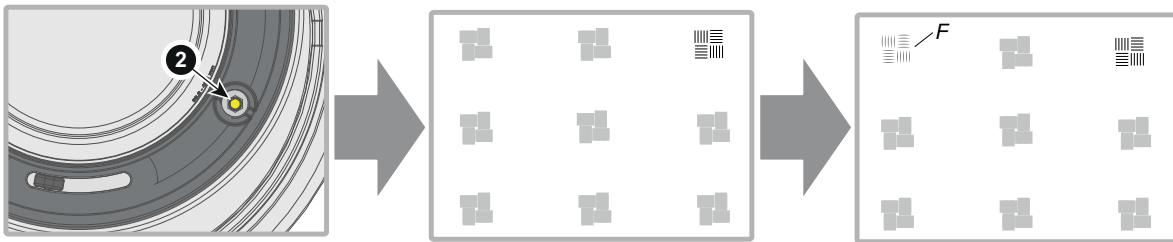



Image 3-11

4. Adjust the top Scheimpflug adjustment screw (reference 3) until the test image in the bottom half of the screen is in focus. Use a size 4 hex key to do this.

 *Note:* This process may cause the other areas of the image to slide out of focus. This is totally normal.

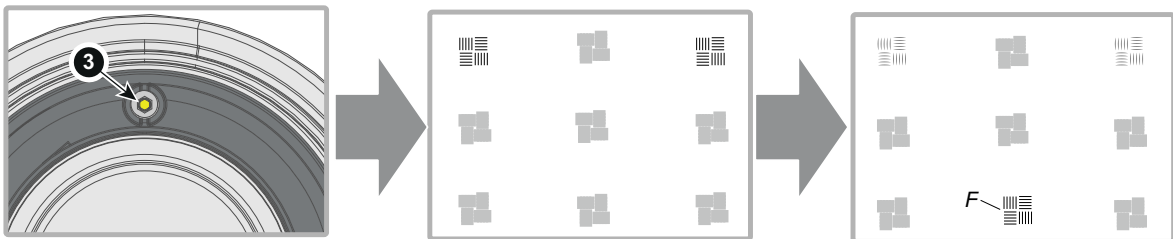

Image 3-12

5. Continue adjusting the screws one at a time until the test image is uniformly sharp across all areas of the display.
6. Test the focus by zooming out (minimum image size on screen) and then zooming in again. Verify the image is still sharp. If there are any deviations to sharpness, repeat steps 2 to 6 until the image is correct.
7. Tighten the three set screws in the following order: left (1b), right (2b) and then top (3b). Use a size 6 hex key to do this.

Getting the projector started

4

4.1	Projector source and control connections	50
4.2	Power up the projector	57
4.3	Power down the projector	58
4.4	Power mode transitions	59
4.5	Power modes	66
4.6	Customize projector settings	67
4.7	User interface.....	68

4.1 Projector source and control connections

4.1.1 Input source connections



The source switching time is variable and could take few seconds..

Source signal connectivity

The connector panel at the back of the projector is used for all source connections.

Source signal connectivity on the projector is:

- 2x Dual Link DVI-I (DVI-D functionality)
- 2x DisplayPort 1.2
- 1x HDMI 2.0
- 1x HDBaseT

4.1.2 Connector Specifications

4.1.2.1 DVI-I

Specifications

Parameter	Value
Connector	DVI-I female digital RGB
Signal characteristics	DVI 1.0, Digital, TMDS
Max. cable length	25 m (24 AWG)
Max. pixel rate	330 MHz (dual link), 165 Mhz (single link)
Scan format	Progressive
Max. input data resolution	1920x1200 60Hz (Single link), 2560x1600 60Hz (Dual Link), 1920x1200 120 Hz (Dual Link), 1920x2400 @60Hz
Bit depth	8 bit
EDID	Supported
HDCP	Supported

4.1.2.2 Display Port 1.2

Specifications

Parameter	Value
Connector	Standard Display port
Signal characteristics	DP 1.2
Functionality	Mandatory
Max. cable length	2 m (24 AWG) - RBR; 2 m (24 AWG) – HBR1, HBR2
Supported Link Rate	RBR, HBR1, HBR2
Scan format	Progressive
Max. input data resolution	2560x1600@120Hz WQXGA / 3840x2400 @60Hz (4K) Max
Bit depth	8, 10, 12 bit
EDID	Supported
HDCP	Supported

4.1.2.3 HDMI 2.0

Specifications



Regarding HDMI 2.0: The decryption protocol HDCP 2.2 are enabled and valid in this unit.

Parameter	Value
Connector	Standard HDMI
Signal characteristics	Digital, TMDS
Max. cable length	2 m (24 AWG)
Max. pixel rate	594MHz
Max. input data resolution	3840x2160 @60Hz
Bit depth	8, 10, 12 bits
EDID	Supported
HDCP	Supported
Ethernet	No
Audio return	No
HDCP	Supported

4.1.2.4 HDBase T



The HDBaseT standard allows the link to also be used as a regular network port. In addition to carrying video data, it can also be connected to regular ethernet network without carry out any video data.

Due to limitations in the projector and network standards, only the LAN and the HDBaseT should be used for network traffic, but not both simultaneously. If both are connected simultaneously it might lead to undefined behavior where traffic is not being sent on the link indicated by the IPaddress.

This is only valid when the projector has a firmware version 2.1 or higher installed.

Specifications

Parameter	Value
Reference specification	HDBaseT 1.0 Specification, June 2010
Connector	Standard RJ-45, 8P8C
Signal characteristics	HDBaseT
Max. cable length (1080p/48b/60Hz)	100 m (Cat5e/6), Pixel Clock <=225MHz, Video Datarate <=5.3Gbps 70 m (Cat5e/6), Pixel Clock >225MHz, Video Datarate >5.3Gbps 100 m (Cat6a/7), Pixel Clock >225MHz, Video Datarate >5.3Gbps
Max TMDs Clock Frequency	270 MHz
Max video resolution supported	4096x2160 @30Hz
HDCP Pass-Through	Yes, from Source to Projector
IR Extension	Not Supported
RS-232 Extension	Not Supported
10/100Mbps Ethernet Pass-Through	Not Supported
Fallback to 100BaseTx, IEEE 802.3u	Not Supported
USB Over Centre Tap	Not Supported
Power Over Ethernet	Not Supported
Audio	Not Supported
LEDs - HD Base Status	Operation: Green, Left Link/Mode: Yellow, Right

4.1.3 Control Interfaces



The HDBaseT input can also be used as a regular network port. See [“Connector Specifications”, page 50](#), HDBaseT specification.

HDBaseT as network input

About

The following control interfaces are available on the projector:

- 1x RS-232 (for projector control)
- 1x LAN/Ethernet (for projector control)
- 2x USB-A ports

4.1.3.1 RS-232

Specifications

Parameter	Value
RS-232 connector	1 female DB9 connector (RS232-in) for projector control and debug

4.1.3.2 LAN/Ethernet

Specifications

Parameter	Value
Ethernet connector	1 RJ45 Connector for projector control (not content)
Protocols	DHCP, TCP/IP, UDP/P
Speed	10/100 Mbit/1000Mbit

4.1.3.3 USB-A port

Specifications

Parameter	Value
USB connector	Type A
Function	Firmware upgrade using USB sticks
Power	Power 5V, max 1,5A (out)
Standard	USB 2.0

4.2 Power up the projector



CAUTION: Sources should always be connected before the projector is powered up



CAUTION: Ensure that the main power cord complies with the national regulations where the equipment is used.

Do not use unauthorized replacements.

Do not use power cords which are damaged.

Power up the projector using the keypad or remote

1. Connect the line cord to the projector.
2. Plug the 3-pronged cord into a grounded AC outlet.
The projector will begin warming up, and the backlight of the Standby /power button are flashing white.
3. When the backlight on the standby button are constant white, the projector are in standby mode, ready to be switched on.
4. Press the standby button on the keypad or the power button on the remote to bring the projector up to on mode.
The power button backlight on the keypad will flash blue while the projector is warming up.
5. When the power button backlight is steady blue, the projector is ready for use.

4.3 Power down the projector

Power down using the keypad or remote

1. Depress and hold the power button on the keypad or remote for four (4) seconds.
The Projector is now in cooling down phase.
2. Wait 2 minutes before disconnecting the power cord. (If disconnecting is required).



WARNING:

There is a risk of reducing the expected lifetime of the projectors DMD device if the power cord is removed too early, due to the device's shutdown sequence.

4.4 Power mode transitions

4.4.1 General

Transition Diagram

This diagram shows all modes available on the projector (unplug, ON, READY, ECO), and the actions necessary to change mode.

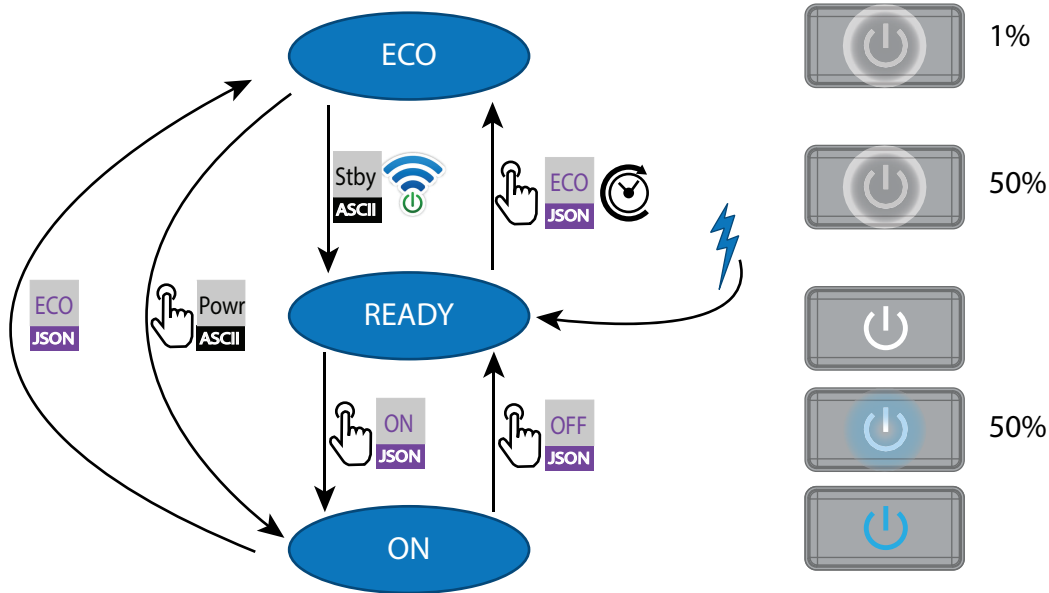





Image 4-1

-  Projector mains powered
-  Auto transition after x minutes if ECO mode enables
-  Press power On/Off button, remote On/Off button

4.4.2 Power on projector



If not already connected, connect the female side of the power cord with the power input socket of the projector. For more details see section dedicated to the power cord installation.

Description

Plug the 3-prong plug of power cord into a grounded AC outlet. The projector will go to **READY** mode. During this stage the system boots and performs the internal check of the boards. The *Power On/Off button* will BLINKING WHITE until **READY** mode is achieved. Once in **READY** mode, the *Power On/Off button* will be lit WHITE.

4.4.3 Going from READY to ON

Description

Press the *Power On/Off* button on the projector, or the *Power On* button on the remote control. The projector will power **ON**. The *Power On/Off* button will BLINK BLUE during the transition from **READY** to **ON**. Once the projector is on, the *Power On/Off* button will be lit BLUE.

4.4.4 Going from ON to READY

Description

Press and hold the *Power on/off* button on the projector for 4 seconds, or press the *Power Off* button on the remote control. The projector will power down through a cool down phase. The *Power on/off* button will BLINK WHITE during the transition from **ON** to **READY**. Once the projector is in **READY**, the *Power on/off* button will be lit WHITE.

4.4.5 Going from READY to ECO standby

Description

If ECO Standby mode is enabled in the service menu (refer to the section "GUI - system settings/Standby ECO", in User Guide) the projector will automatically go to **ECO** standby mode after a time-out (default 15 minutes). All electronics (including fans, pumps,...) go down except for a very small wake up controller. The *Power on/off* button will FLASH WHITE every second.

4.4.6 Going from ECO to ON

Description

Press the *Power on/off* button on the projector, or the *Power On* button on the remote control. The projector goes from **ECO** directly to **ON**. The projector will go through the same booting phase as on power plugging, then do the transition from **READY** to **ON**. Of course startup-time will be longer then from **READY** to **ON**.

4.4.7 Wake On LAN (WOL)

About

The projector has WOL functionality, that can be used for the projector to go from ECO mode to READY mode. Use a json command for transition from READY to ON.

The WOL is performed by sending a Magic Packet followed by the projectors MAC address. The MAC address is found in the *Menu / Settings / Communication / LAN*. menu. The MAC address is similar to the HW address that is shown in this menu path.



The LAN cable must be connected when the projector enter the ECO mode, in order to obtain the Wake on LAN function.

4.5 Power modes

General

The table below details the projector power modes.

Mode	Description
Normal	Projector is booted up and the light source is on
Ready	Projector is booted up but the light source is off
ECO Standby	Light source is switched off and projector electronics are powered down

4.6 Customize projector settings

About

The projector display, behavior and user interface can be adjusted to meet individual requirements.

Options include: *Menu/Settings/Themes*

- Adjust the OSD menu color

4.7 User interface

4.7.1 On Screen Display (OSD)

About

The projector on screen display (OSD) is the primary user interface (UI). From here, you can review and adjust all projector and display settings.

The OSD interface uses tabs to display the main menu. Topics are then further sorted and displayed by function: main (topic) — sub (function) — sub (function).

There are seven main menu tabs: Source, Image, Installation, Profiles, Settings, Test pattern and Status.

The OSD can be disabled by pressing the OSD on/off button.



In order to show the OSD, the OSD On/Off button must be disabled. (White backlight on the button). When the button has blue illumination, the OSD will not appear, and the display information is only visible on the LCD Display. Only Critical warnings will be displayed.

User access levels

The projector's software platform uses access levels to define what each user can do.

There are two user access levels: Standard User and Power User. In addition, there is a Service user access for certified Service personnel.

A standard user has access to all projector functionality and OSD menu items. A power user has, in addition to access to all projector functionality and OSD menu items, access to a number of advanced functions. Access to power user features is password-protected. Contact your projector supplier for more information.

Navigation

You can navigate the OSD using the local keypad or the remote control.

Press the MENU button to display the OSD. (The OSD must be enabled, press OSD button to enable.)

Use the arrow keys to navigate left, right, up and down.

Press the OK button to select a menu topic and get more options.

Use the numeral keys to enter values, or use the arrow keys to move the barscale up or down.

Press MENU again to exit the menu system.

Press the OSD button to deactivate the OSD on the screen. Only critical warnings will be displayed.



Some menu options are reserved for Power or Service Users; these will be grayed out and not available for selection when in standard user mode. To access these features, enter your Power or Service Code in the Service Menu or contact your support representative for more information.

Define values

Menu settings are displayed using checkboxes, barscale sliders, and selection boxes, depending on the type of menu.

To set a value:

- Press OK to select or deselect a checkbox (turn a function ON or OFF).
- Use the arrow keys to move the barscale slider up or down on the value line. For a barscale 0-9, each step will equal 10% of the total value.
- To enter the value as a direct number, press ENTER, input the digit(s), and then Press ENTER again to execute and exit cursor mode e.g. ENTER 79 ENTER.

Changes to values are implemented dynamically.

Menu memory

The OSD menu remembers the last selected sub-item as long as the projector is running. The menu memory is reset when restarting the projector from standby.

Source menu

5

5.1	Connector selection	70
5.2	Connector settings.....	71
5.3	Using dual inputs	74

About the Source menu

This menu is used to select, review and configure sources into the projector. Enables either via the source menu, or the shortcut key.

By navigate through the Source menu, it will be visible also on the OSD.

By using the shortcut key, the menu occurs only on the LCD display.

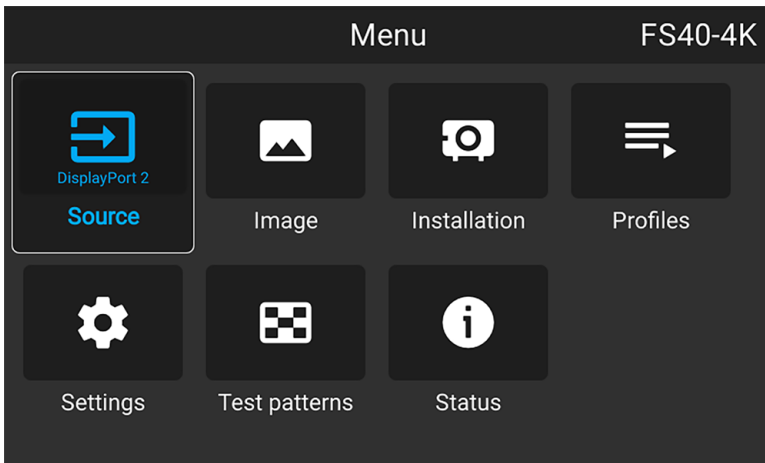

Image 5-1

5.1 Connector selection

About

Menu/Source

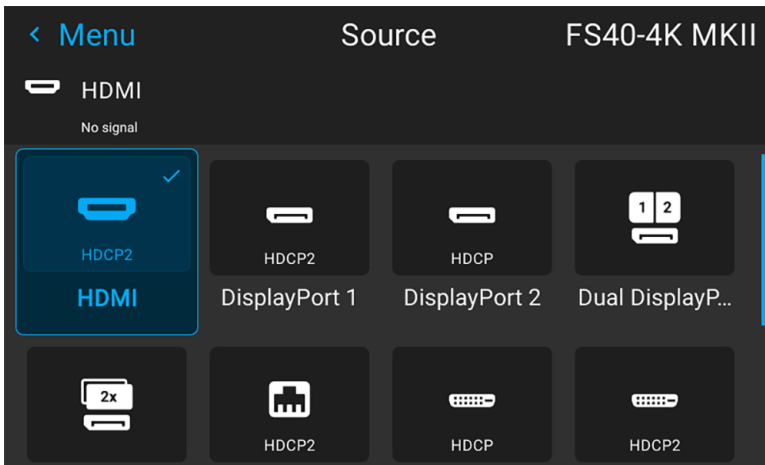

Image 5-2

Click on the relevant input connector icon to swap or activate the source.

The icon for the active source is highlighted.

The list of displayed sources can be adjusted to include other connectors.

The default selection of connectors displayed is:

- HDMI
- Display Port 1
- Display Port 2
- Dual Displayport Columns
- Dual Displayport Sequential
- HDBaseT
- DVI 1
- DVI 2
- Dual DVI Columns
- Dual DVI Sequential

5.2 Connector settings

About connector settings

The Connector Settings menu allows you to change settings for each input connector of the projector.

By default all options for every connector are set to automatic, together with the native Extended Display Identification Data (EDID).

When entering the menu for each input connector, you can change the following:

- Color Space
- Signal Range
- EDID

How to configure a connector

1. Press **Menu** to activate the menus and select *Source*.

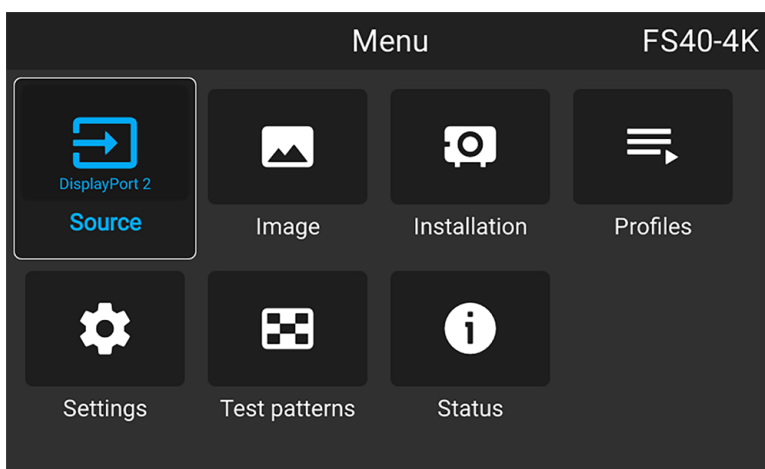

Image 5-3 Select source

2. Press **OK**.

The *Source* menu is displayed with the actual available sources filled out.

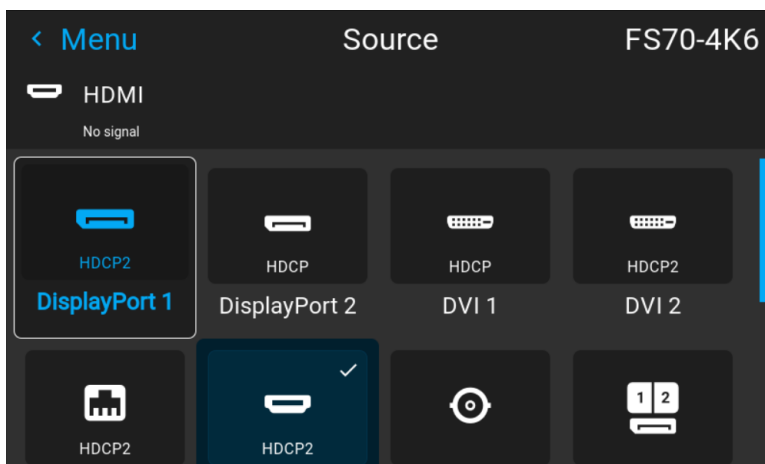

Image 5-4 Source menu

3. Scroll down to the bottom of the list of available sources and select *Connector Settings*.

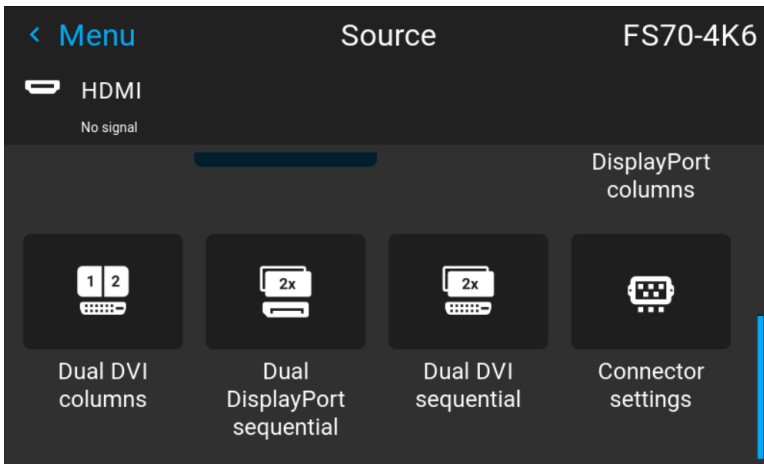

Image 5-5

The available input connectors are displayed.

4. Select the desired connector.

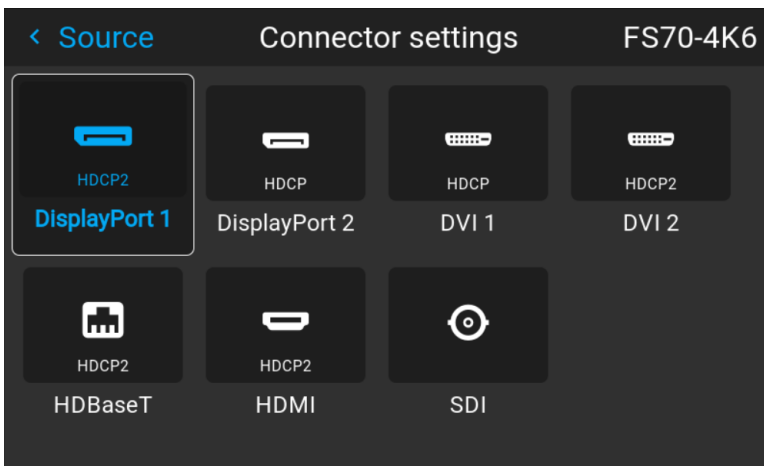

Image 5-6

The **Connector Settings** menu for this connector will be displayed.

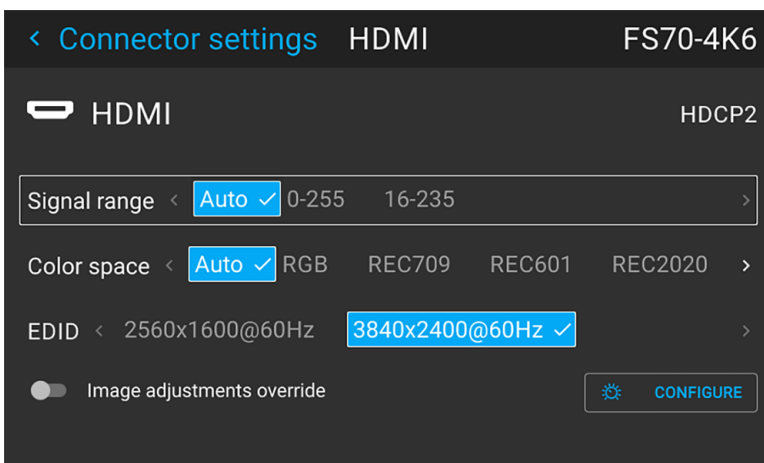



Image 5-7 Example of connector settings of an Displayport Connector.

5. You can change the following:
 - To force a limit on the color space, select one of the available *color spaces*.
 - To force a limit on the used signal range, select one of the available *signal ranges*.
 - To set a video timing other than the one native for the connector, select one of the options under *EDID*.

 *Note:* You cannot change the EDID for SDI connectors.

5.3 Using dual inputs

Dual Input.

For extended flexibility to connect high resolution sources with a pixel clock over 330 MHz, the projector is supporting a dual input mode. In this mode, the left and the right half of the image can be connected to the DVI-1 and DVI-2 respectively, or DP1 and DP2.

To enable this mode, select the source that fits in the *Menu/Source*

Dual input modes

There are four ways to connect dual input.

- Dual Displayport Columns
- Dual Displayport Sequential
- Dual DVI Columns
- Dual DVI Sequential



For Images to be displayed in this mode, the resolution must be the same on both channels

Signal source setup.

When using dual inputs, it is important that the signal sources are set up correctly, with the correct resolution. Please refer to the manual for the source itself (PC, Graphic driver card..) in order to obtain a correct setup. If the setup is wrong, no picture will be visible in dual mode.

The resolution for each dual column channel can be up to 1920x2400 pixels.

The resolution for each dual sequential channel can be up to 2560x1600 pixels. (4K)



Change the EDID for each channel to the correct value. See chapter "Connector Settings" for EDID setup.

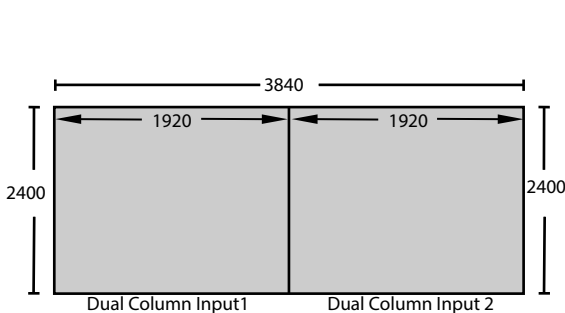

Image 5-8 Dual Column Setup

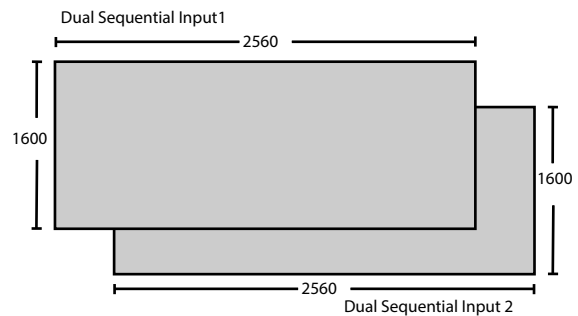

Image 5-9

6

Image menu

6.1	Contrast.....	77
6.2	Brightness.....	78
6.3	Saturation	79
6.4	Sharpness	80
6.5	Gamma adjustment	81
6.6	Gamma Types.....	82
6.7	Digital Zoom Shift	83
6.8	Advanced image adjustments.....	86

About Image adjustment menus

There are different menu pictures showing up for the LCD display and the OSD. For the LCD display, the menu is shown below. The OSD menu is shown in the different topics below, and is visible in the lower left corner of the screen. The operation of the menus can be done with both the remote control or the arrows on the keypad. It is also possible to switch between the different adjustments by using the up and down arrows, instead of exit one menu and then enter the next one.

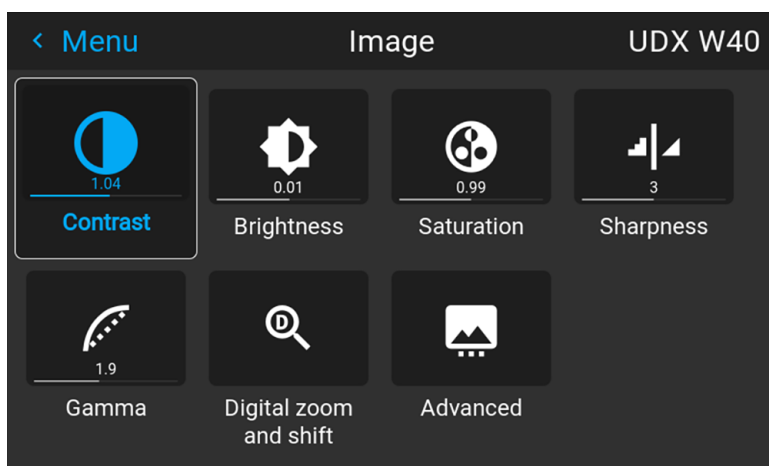

Image 6-1

Entering Contrast, Brightness, Saturation, Sharpness or Gamma menus from the keypad.

When entering any of these menus from the Keypad, the screen below will show up in the LCD panel. Use the arrow keys to select and adjust the values.

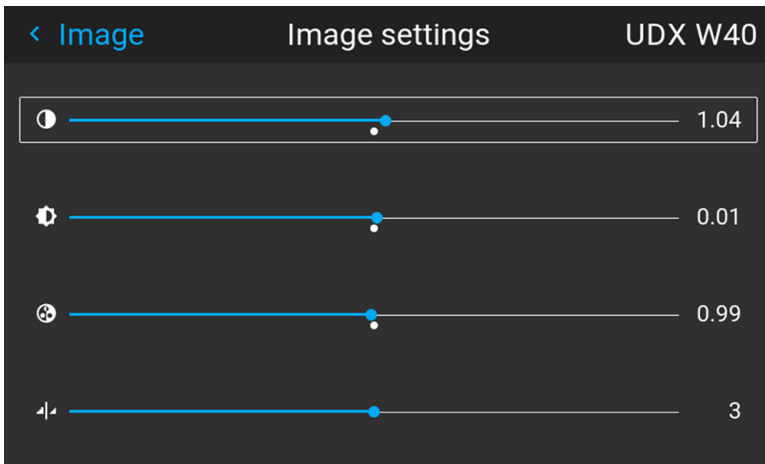

Image 6-2

When pressing enter on the value slider, this icon will show up on the OSD (depending which setting that is enabled, contrast showed here). When in this mode, use the up and down arrow keys to navigate between the different settings.

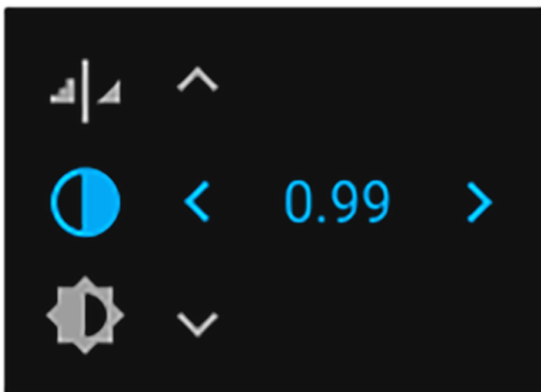

Image 6-3 OSD menu

6.1 Contrast

About

Image / Contrast

Used to adjust the contrast ratio of the displayed image by applying gain to the red, green and blue signals.

Available range: 0.00 to 2.00

Default value: 1.00

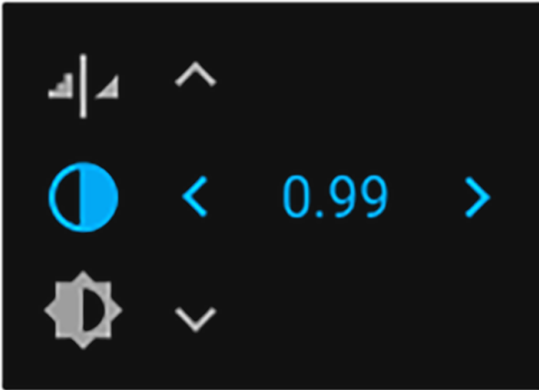

Image 6-4



When inside this menu, it is possible to change to the other image adjustments (Brightness, Saturation, Sharpness and Gamma) by using the up and down arrows on the remote control or keypad.

6.2 Brightness

About

Image / Brightness

The brightness function is used to adjust the black level in the input picture. It adds or subtracts an offset, or bias in to the red, green and blue signals.

Available range: -1.00 to 1.00

Default value: 0.00

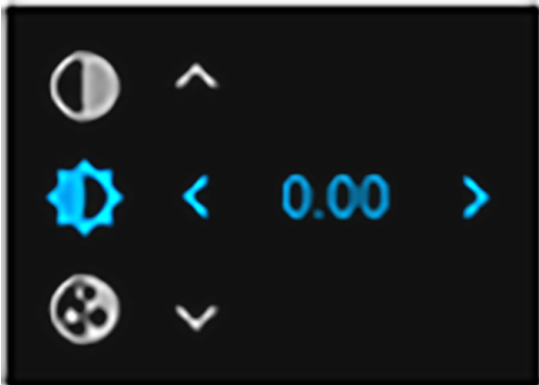

Image 6-5 Brightness OSD menu

6.3 Saturation

About

Image / Saturation

Saturation levels impact on the white levels and the intensity of the color display; the higher the value, the more vivid the color display will be.

Available range: —1.00 to 2.00

Default value: 1.00

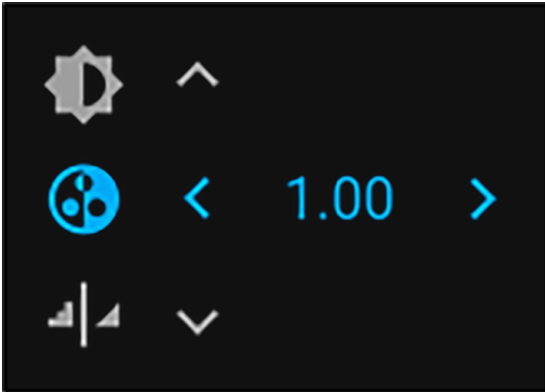

Image 6-6 Saturation OSD menu

6.4 Sharpness

About

The sharpness adjustment amplifies the high frequency components in the picture, meaning that by increase the sharpness, the picture will be perceived as sharper, and if decreased, the picture will be perceived as more blurry.

Increasing the sharpness will have the best effect in high contrast images, eg a table with text and borders.

In a natural picture, high sharpness can be perceived as noise, as all details in the picture will be amplified.

Available range —2 to 8.

Default value: 0

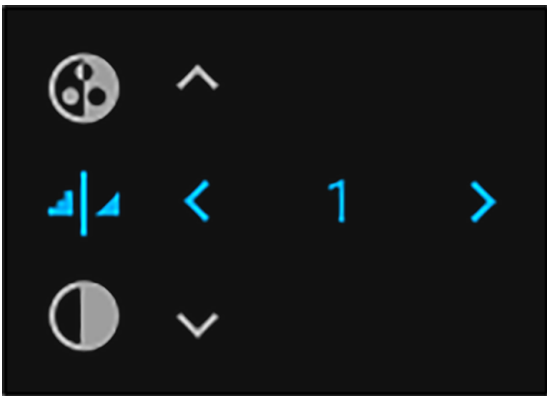

Image 6-7 Sharpness OSD menu

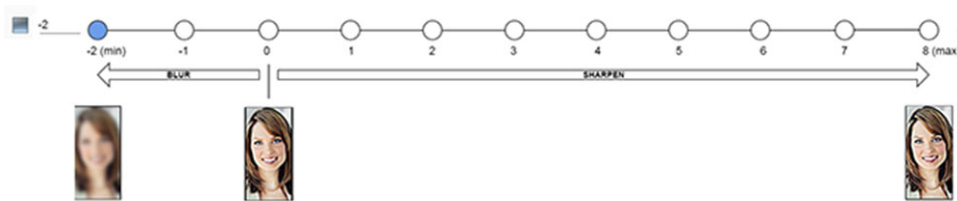

Image 6-8 Effect of sharpness adjust

6.5 Gamma adjustment

About gamma correction.

Gamma compensation, or gamma correction, is a way of adjusting the signal input to light output characteristics of a display or projector in order to suit the eye's sensitivity to different light levels and to compensate for non-linearities in displays. Without gamma compensation, images may look too dark or too bright, lack detail or depth. By adjusting the amount of gamma compensation changes, you change only the perceived brightness levels.

Different types of displays have different gamma factors that need to be corrected in order to look and be perceived the same. For example, an MS Windows generated image displayed on a CRT monitor will require a gamma correction value of about 2.5 to avoid color bleaching and burning.

The gamma curve correction formula is based on output level \propto input level $^{\wedge}$ gamma.

1. Enter the *Image* menu, and select Gamma.

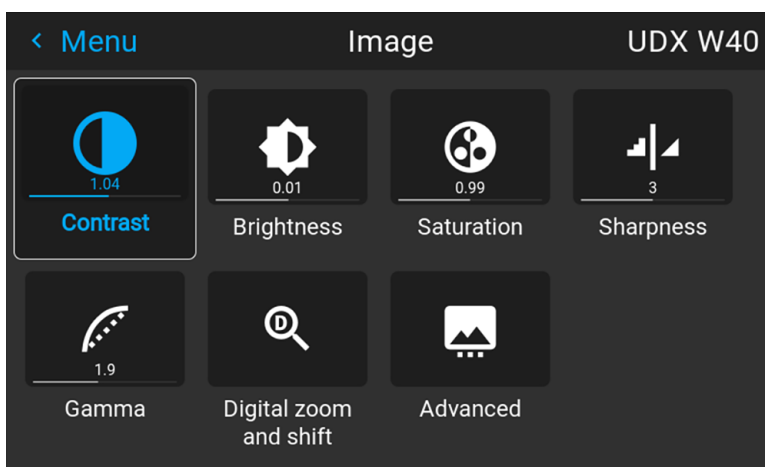



Image 6-9

2. Use the arrow keys to select the most suitable gamma type.
3. Select the gamma slider and tune the gamma value.

 **Note:** The Gamma slider in the Gamma menu will be disabled when DICOM, SIM or SRGB values is selected.

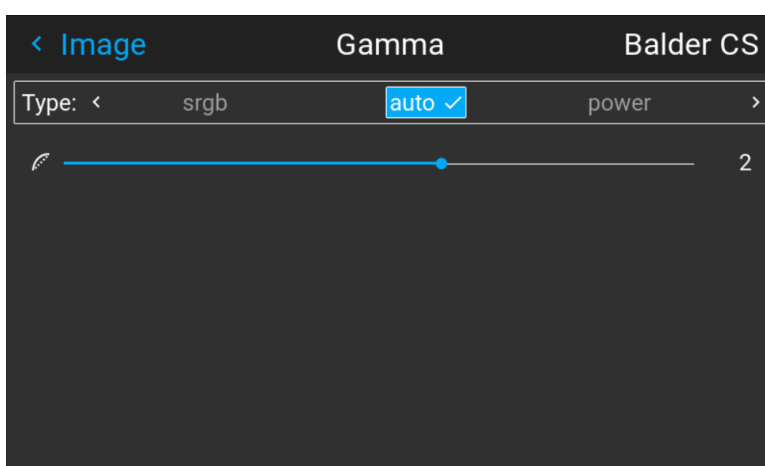

Image 6-10

6.6 Gamma Types

6.6.1 Predefined Gamma types

About

The Gamma Type selection contains several predefined Gamma settings for the most common user cases.

How to select Gamma type

1. Enter the menu *Image / Gamma*
2. Press enter, and scroll horizontally in the menu and select the proper Gamma value.

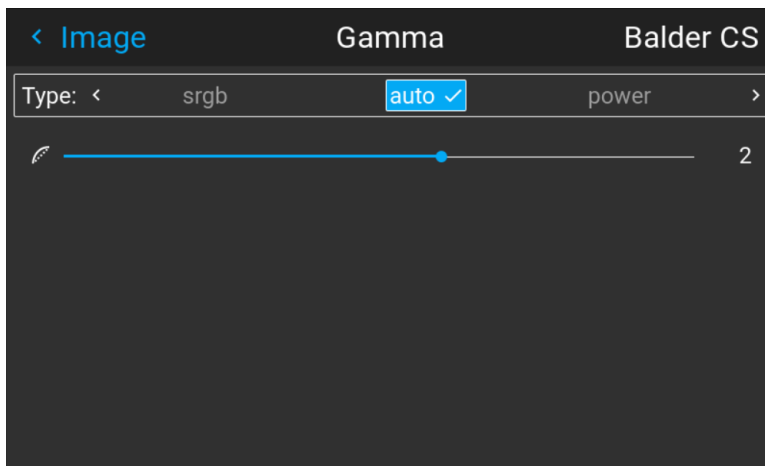

Image 6-11

3. Select the gamma type that match the setup in the source to obtain an optimal rendering.

6.7 Digital Zoom Shift

About

The digital zoom and Digital Shift functions are both entered from the same menu. The menu shows how to toggle between zoom and shift adjustment.

Enter the menu shown below, either via the Remote control or the keypad.

The combined menu is showed below.

The symbols on the lower part of the menu are symbols showing how to operate the keypad / remote control for the digital shift / digital zoom modes..

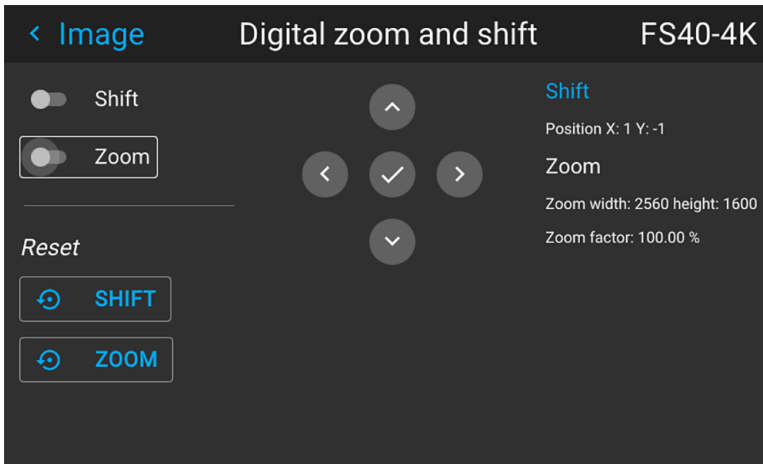

Image 6–12

6.7.1 Digital Zoom

Digital Zoom

This function will zoom the picture digitally. When zooming in, the center of the image will increase in size. This means that the outer part of the picture will be outside the projector's picture frame. When zooming out, the result is that the picture will be smaller than the projector's picture frame. The area outside the rendered picture will then be black.

See the illustrations below. The red lines in the figures represent the DMD outline.

Enter the menu showed above and toggle the Digital zoom switch. Select the slider according to the instructions in the menu and move it to the desired zoom level.

The numbers on the right side of the menu represent the "new" resolution of the picture (assuming that the whole picture should be visible) in pixels. The aspect ratio will not be affected by the zoom function.

This function can also be used in combination with digital shift.



Image 6–13 Originally picture, not digitally zoomed



Image 6–14 Picture digitally zoomed in

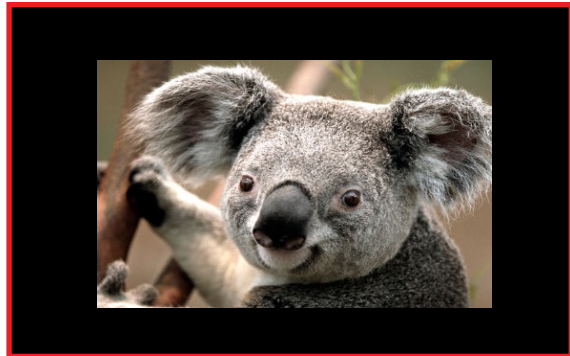

Image 6–15 Picture digitally zoomed out

6.7.2 Digital Shift

Digital Shift

This function will shift the picture digitally, meaning that the picture will be moved in any direction. As a result, some parts of the picture might be shifted outside the DMD range.

See the illustrations below. The red lines in the figures represent the DMD outline

Enter the menu showed above and toggle the Digital shift switch. Select the slider according to the instructions in the menu and move it to the desired shift level.

The numbers on the right side of the menu represent the movement (shift) of the picture in pixels referred to the “no shift” position. Positive numbers are shift right/down, and negative numbers are shift left/up.

This function can also be used in combination with the Digital zoom function.

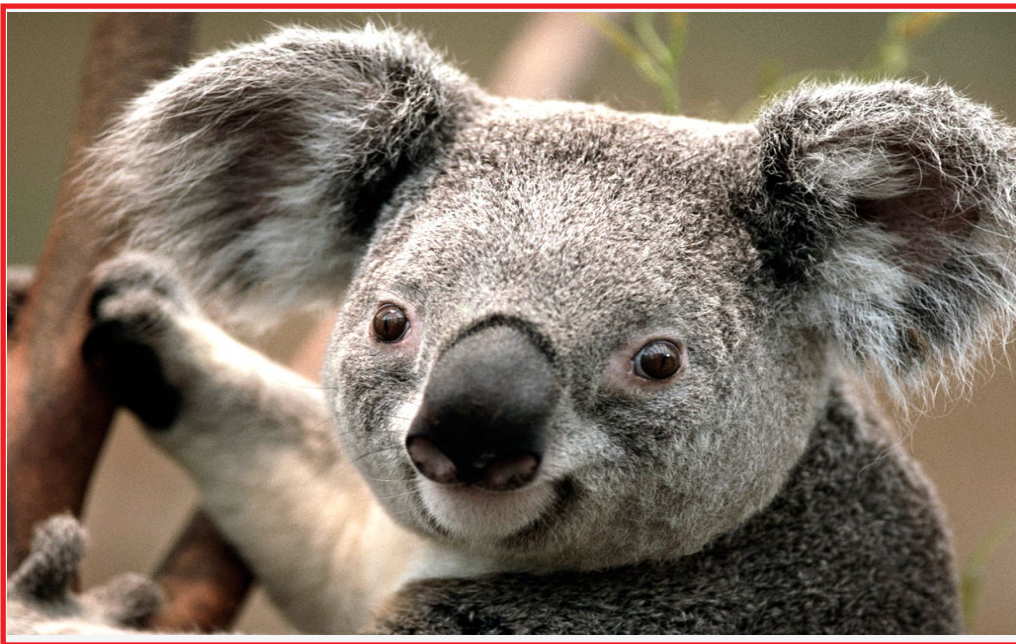

Image 6–16 Original Picture, not digitally shifted

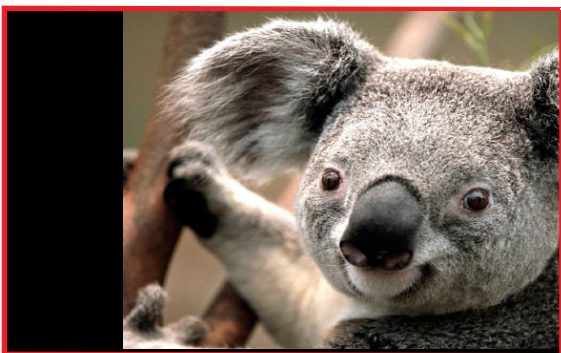

Image 6–17 Picture shifted horizontally

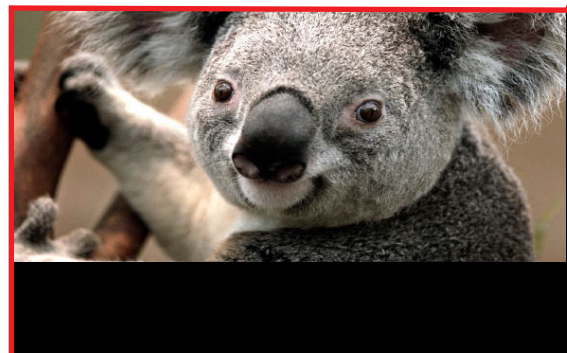

Image 6–18 Picture shifted vertically

6.8 Advanced image adjustments

6.8.1 P7 Realcolor

Purpose

When blending images from multiple projectors, the perceived color coordinates of each projector can be altered to a desired common level, so that the projected colors are identical over all projectors used.

Alternatively, if you are unfamiliar with how adjusting the Colors to a specific setting, there are also a certain number of presets available, which forces the color output to specific color standards.

How to choose one of the P7 presets

1. In the main menu, select *Image / Advanced*

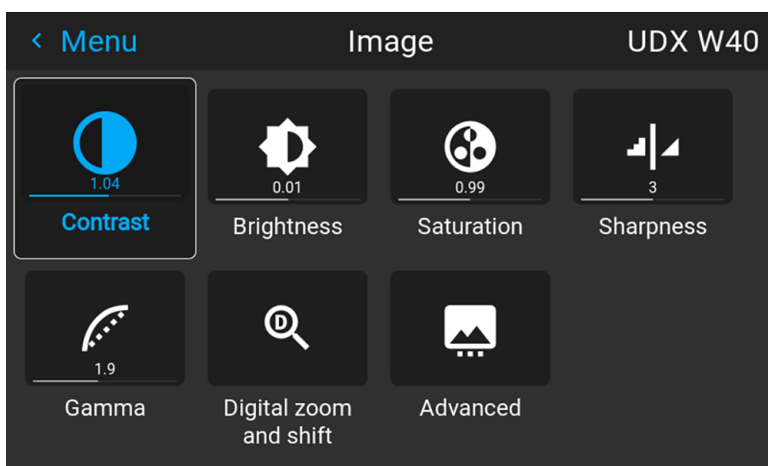

Image 6–19

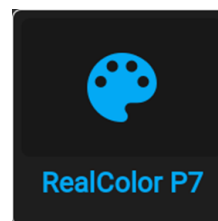

Image 6–20 Advanced menu — P7 Realcolor

2. Scroll horizontally and select one of the pre-defined presets:
 - **Native:** Projector native color settings. Default setting
 - **EBU:** European color standard for broadcasting
 - **SMPTE-C:** American color standard for broadcasting.
 - **Rec. 709:** Color standard for high-definition televisions (HDTV).

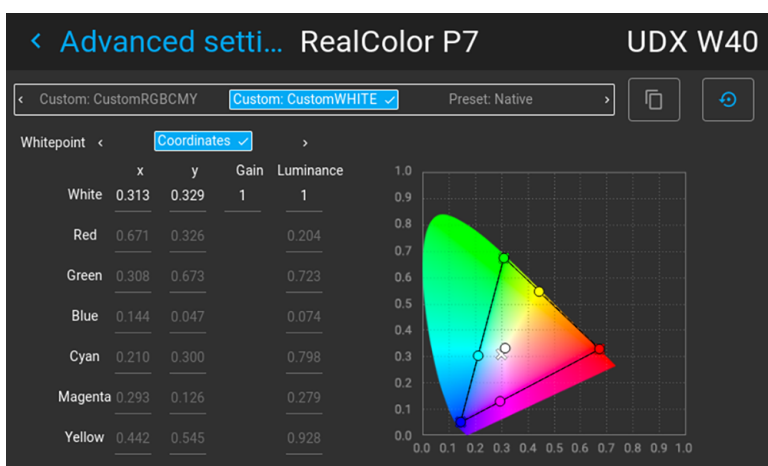



Image 6–21

 **Note:** When choosing one of the presets, All other options in the P7 menu are disabled.

How to set custom P7 values

1. In the main menu, select *Image* → *Advanced* → *P7 Realcolor*.

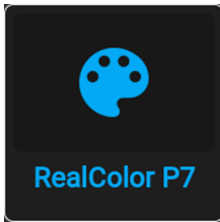

Image 6-22

The P7 menu is displayed.

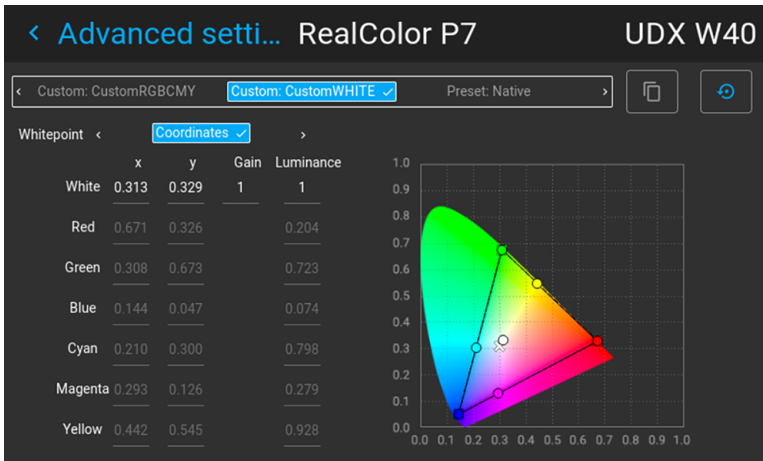

Image 6-23

2. Scroll horizontally and select one of the following *custom* options:
 - **Custom RGB:** 3–point color configuration.
In RGB mode, the C, M and Y coordinates will be calculated automatically based on the R, G and B coordinates.
 - **Custom RGBCMY:** 6–point color configuration (both RGB and CMY).
In RGBCMY mode, each color can be given a specific coordinate within the measured color triangle.
 - **Custom WHITE:** Configure only the White temperature.
3. Define the coordinates for each available color.
Click on a coordinate value and select the current value. Enter the desired value with the numeric keys.
 - 📄 *Note:* You can only pick coordinates within the measured color triangle.
4. For **Custom White**, click on White point and choose one of the following:
 - **Coordinates:** Configure the white point via specific coordinates.
The white point is specified using an x, y coordinate in the CIE 1931 Chart.
 - **Temperature:** Configure the white point via a color temperature slider.
The white point is specified on a Kelvin scale between 3200K and 13000K tracking along the black body curve.



You can reset all coordinates to the default values (to native) by selecting Reset modes to native. Press **OK** button to reset.

6.8.2 Edit the RealColor presets.

Editing presets

The different presets in the Real Color menu can be edited to obtain an optimal rendering of the picture.

Enter the *Menu/Image/Advanced/P7 Realcolor.*

menu.

Select the desired preset mode (EBU, Rec709 or SMPTE-C) and select the coordinate within each color component that has to be corrected. Enter the desired value either by:

- Using the keypad to increase /decrease the selected value by the arrow keys.
- Using the remote control: Erase the existing value with the “ * ” key, and enter the new value by the numeric keys.

The values are stored for the preset, until the “Reset” button is enabled, or when a factory reset is performed. There is also a possibility to store the values in the custom presets.. Press the “Copy preset to custom” button to save.

The edited presets can be reset to the original values by enter the Reset button. There is also a possibility to copy the values to the custom preset.

To reset the values in Custom presets, enter the “Reset to native” button when in Custom mode



Image 6–24 Preset Native selected

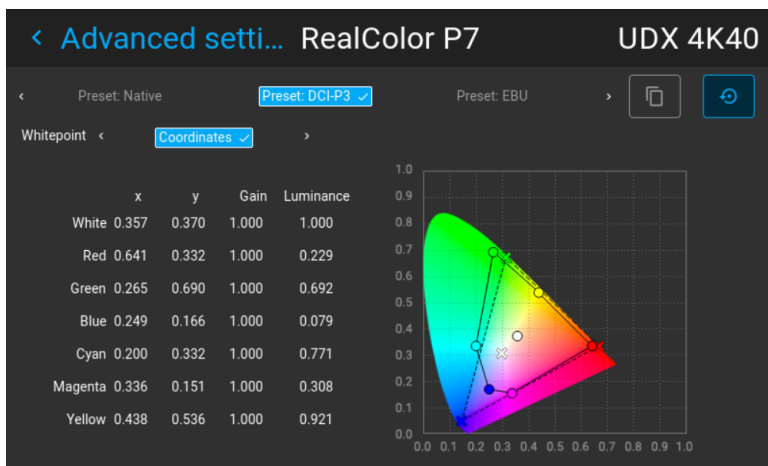

Image 6–25 Editable values

6.8.3 Output resolution 4K

About

With this function, the projector output resolution can be changed between 4K UHD resolution and WQXGA resolution.

Refer to the chapter “Projector source and control connections” regarding use of input sources in 4K mode.

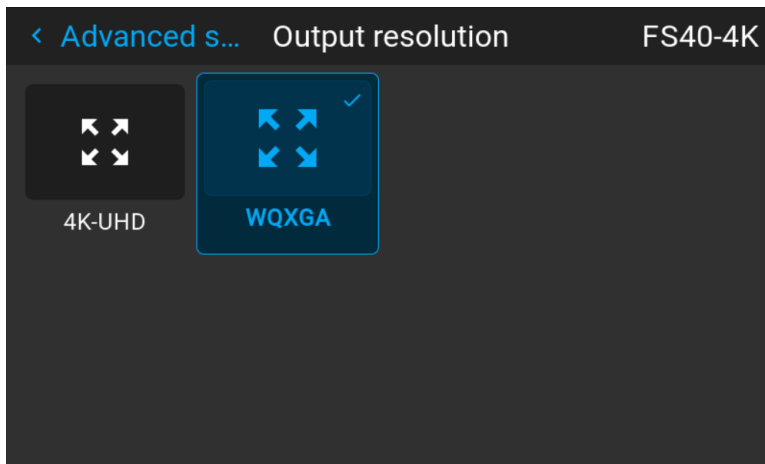

Image 6–26 Output resolution menu

6.8.4 Brilliant color

About

Optimizes the color rendering, by adjusting the light intensity. This has the effect of changing the color intensity, and by that also the perceived light intensity.

Enter the menu, and select the option that give the best result

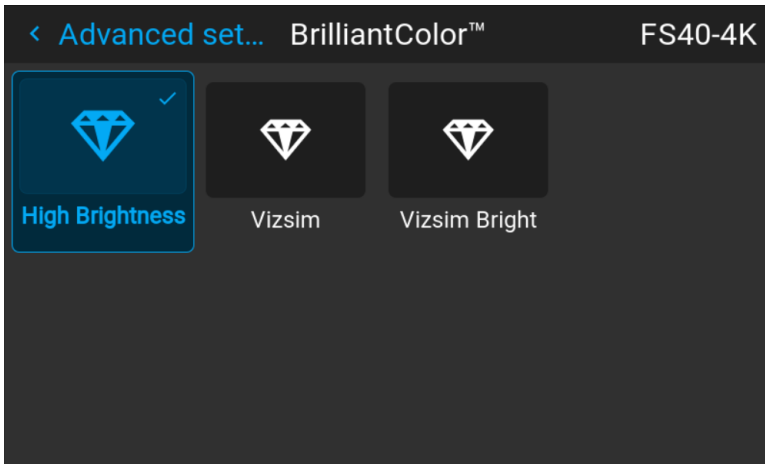

Image 6-27

6.8.5 Displaying HDR content– Perceptual Quantizer (PQ)

About PQ

Perceptual Quantizer (PQ) is a non-linear electro-optical transfer function (EOTF) that allows for the display of High Dynamic Range (HDR) content with a luminance level of up to 10 000 cd/m² and can be used with the Rec. 2020 color space.

How to properly display HDR content?

If your provided HDR content has been mastered with PQ (e.g. HDR10 and Dolby Vision), a few changes can be made in order to project the intended mastering on screen. These changes are necessary because HDR content has been mastered specifically for HDR capable displays that are watched in living rooms. These conditions are different from a non-HDR projector and darker cinema-like environments.

The projected HDR content depends on the following factors:

- **Mastering luminance:** This is content-specific and cannot be changed.
- **Screen luminance:** Every projection screen has a specific luminance (measured in nits or foot-lambert). Entering this luminance in the projector will adapt the content towards the intended HDR result.
- **HDR Boost:** A variable “booster” that may amplify or downplay the HDR output.

How to set the PQ?

1. In the main menu, select *Image* / Advanced settings / HDR
The HDR menu is displayed.
2. Select the desired Unit (nits or foot-lambert).
3. Enter the Screen luminance (either in nits or foot-lambert).
4. Alter the HDR boost if necessary. You can modify this value to somewhere between 0.8 and 1.2.

6.8.6 HDR PQ tone mapping (Light)

About

When a user is playing HDR content, every movie mastered with different brightness level, while the projector is configured to only play on 1 brightness level. As a result when a brightness mismatch occurs the image is either washed out or too dark. Without this feature playing HDR content is really not possible.

Functional description

This is an automatic function in the projector, and normally this will fully compensate for the variance in the brightness level.. But in some cases there can be necessary to adjust manually. This is possible via the menu *Home/Image/Advanced/PQ*.

Enter the menu, and move the slider to the desired value between 0,8 and 1,2..

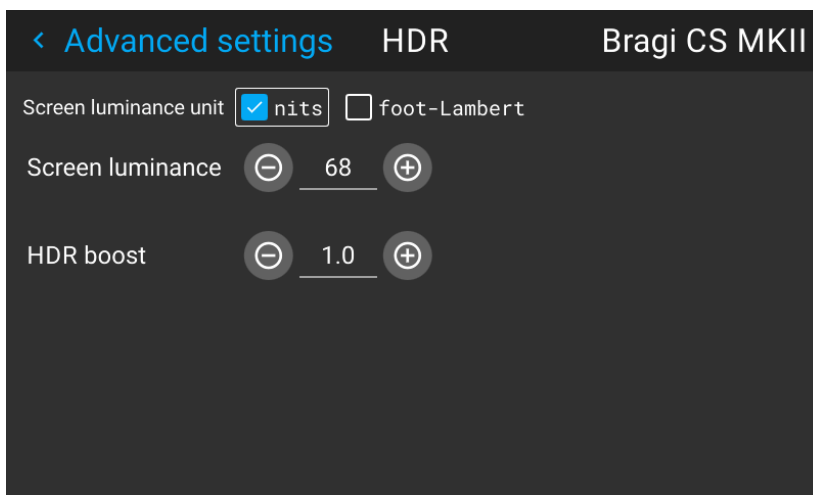

Image 6-28

6.8.7 HDR Status.

When an active source is HDR, an icon is visible in the status menu.

The HDR icon will also be visible in the “Source signal popup” icon in the lower right corner on the screen.

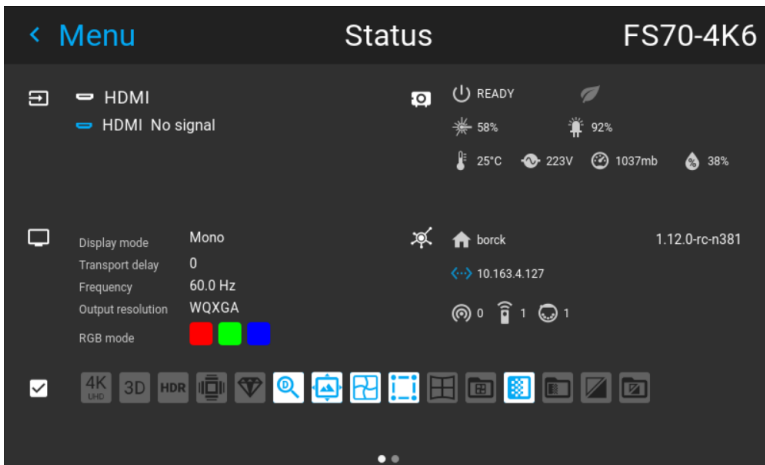

Image 6–29 HDR Icon.

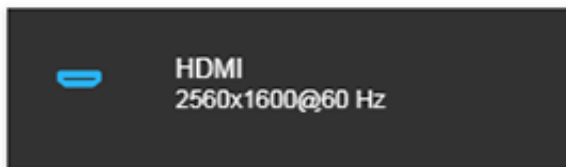

Image 6–30 Source signal popup icon.

6.8.8 Color Primaries

When using an input with another and “wider” color space than the projector's capability, (as an example; REC2020 vs REC709), colors in the REC2020 spectrum that is within the REC 709, will remain the same.

In cases where the colors are outside REC 709, the projector will calculate a color within the REC 709 spectrum that is close to the rendering in REC2020, in practice a saturated color along with the outer border of the REC709.

See figure “Rendering Principle” below, that shows a simplified representation of this principle.

See a separate manual for details and additional information regarding this feature.

Enter the menu *Home/Source/Connector Settings/(Select input)*

The menu window shown below is displayed. (The same menu appear for all inputs).

Select the correct parameter settings in the drop down menus. When using the Auto parameters, the projector will determine the input primary colors.

By selecting the “Uncorrected” setting in the Color Primaries drop down menu, the signal is not processed.

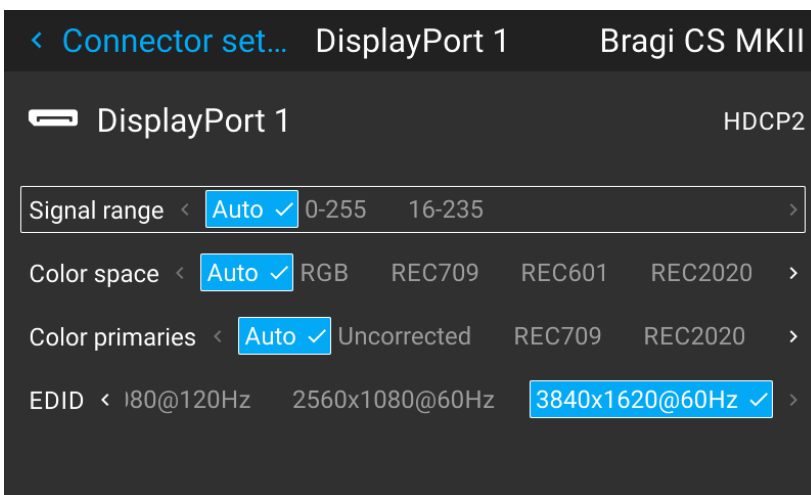

Image 6–31 Menu picture. Equal for all inputs.

Rendering Principle.

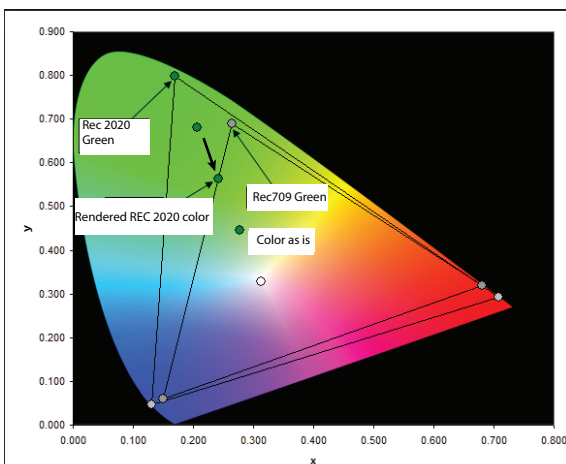

Image 6–32 Rendering principle. Simplified representation.

6.8.9 Night vision

About

When using e.g. displayport 1 as daylight image input, and displayport 2 as night vision input, this option make it possible to swap these two channels in the image processing in order to synchronize with the NV goggles.



This function is only available for the FS variants of the projector.

How to swap channels

Select the *Menu / Image / Advanced / Night Vision*.

menu

Toggle the Swap channel function on / off by pressing the OK button on the remote control or the keypad.

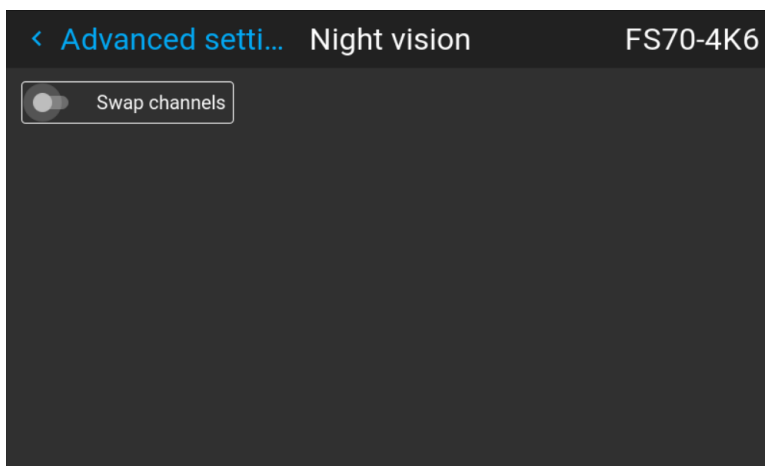

Image 6-33

Advanced picture adjustments

7

7.1 Cropping the image

About

The Crop function is only available for Cinemascope projectors.

Cropping is used to manage image loss and/or letterboxing when the aspect ratio of the projector display and the image source do not match.

A movie in letterbox (black bars over and under the picture) will in a cinemascope projector (aspect ratio 2,35:1), be centered with a black border above, below and on the sides of the image.

To avoid that, and use the full image of the projector display, the crop function is used.

The projector are set up with two different crop methods; Preset and manual.

Cropping Modes.

There are three crop modes; Preset manual and auto.

The most common is to use the preset mode. The preset values are 16,9, 1,85:1, 2,2:1, 2,35:1, 2,37:1 and 2,39:1.

These preset values covers the most common formats. In special occasions where your input format is not covered by these values, the manual mode must be used. When using the preset values, the image is scaled to fill the frame vertically, and at the same time keep the aspect ratio. This means that there will be black bars at the side of the picture.



All cropping is done dynamically. For best result Barco recommend that you pause the movie on the screen, making sure that any subtitles or text are visible. Then activate the cropping function from the menu.

7.2 Preset Crop mode

Perform the cropping function.

The crop can only be applied to the image's vertical position that is the top and bottom of the image.

The images horizontal position will automatically be adjusted to maintain the aspect ratio.

That mean that he crop function will remove the black borders on the upper and lower side of the projected image.

The default setting for the crop function is off.

In Preset mode, the image is altered without constraints to fill the display aspect.

Available aspects are:

- 16:9
- 1,85:1
- 2,2:1
- 2,35:1
- 2,37:1
- 2,39:1

How to preset cropping

Home/Image/Cropping

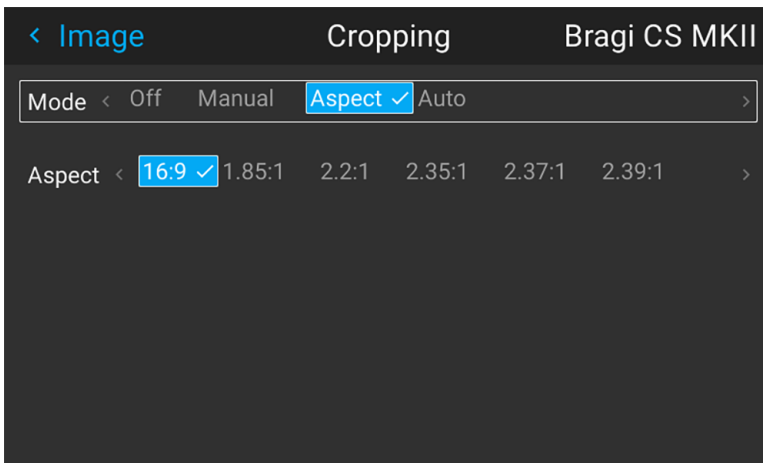

Image 7-1

Enter the menu showed above, and select the input format from the drop down menu.

Exit the menu.

7.3 Manual Cropping

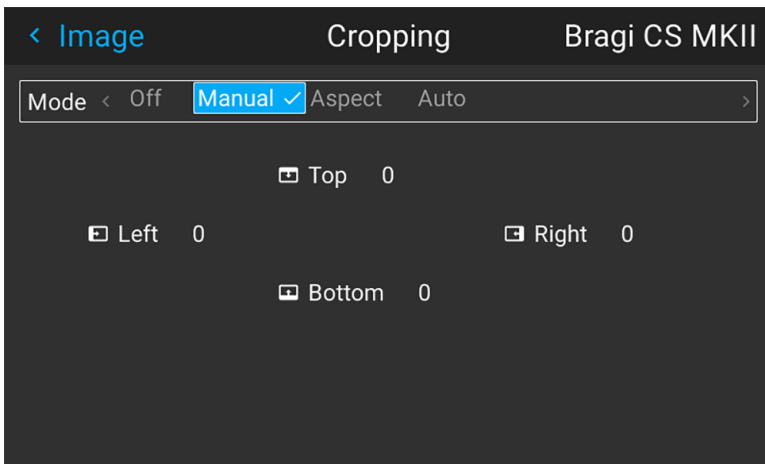

Image 7-2

When the preset values do not match the input format, the manual mode must be used

Enter the menu, and select manual. The OSD will show four numeric values that may be changed, and each numeric value indicates the number of black display lines that shall be removed.

Select the “top” value, and enter a suitable numeric value. If necessary, do several iterations in order to match the correct value.

Select the “bottom” value, and enter the same value as for the “top”.

Then the left and right sides must be adjusted. The value entered here must be equal to the vertical lines removed, multiplied with the aspect ratio, in order to keep the correct correlation between the width and height

. Example: removed 200 lines in 16:9 format: $200 \times (16/9) =$ number of lines to remove on each side.

To keep the subtitles

You can also use the manual cropping to include part of the bottom black bar just enough to include the subtitles when that is being used.

Select the “top” value, and enter a suitable numeric value. If necessary, do several iterations in order to match the correct value to remove the complete black bar.

Then do the same for the “bottom” value until you have removed just enough to still see the subtitles.

7.4 Automatic source cropping

About

This function is only available in Cinemascope variants of the projector.

Enter the menu *Home / Image / Cropping*. When choosing “Auto” in the dropdown menu, the source will be cropped to the detected content aspect ratio.

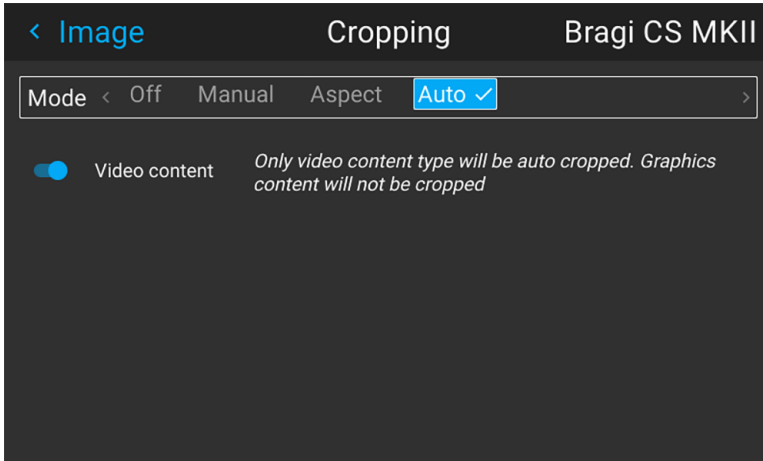

Image 7-3

Reading source content aspect ratio

When choosing “Auto” in the source cropping menu, the source will be cropped to the detected content aspect ratio.

Detect the following content aspect ratios of the content of the image:

- 16:9 (i.e. full frame)
- 1,85:1
- 2,2:1
- 2,35:1
- 2,37:1
- 2,39:1

7.5 Graphic content in autocropping mode.

About

Some mediaplayers will, in addition to a video content, also present graphic content outside the video frame. This content can be different types of non defined information. In autocropping mode, this will cause the video picture to be distorted because the projector will interpret this graphic content as a part of the video frame. To prevent this phenomena, switch “Video Content” is visible when auto cropping is selected. When this switch is enabled, only the video content will be cropped, and not the graphic content. This causes the image to be stable without disturbance from the graphic content.

How to select Video content in Autocropping mode.

Select Auto in the Cropping menu.

Select the Video Content button, and toggle on/off by pressing OK on the remote or keypad.

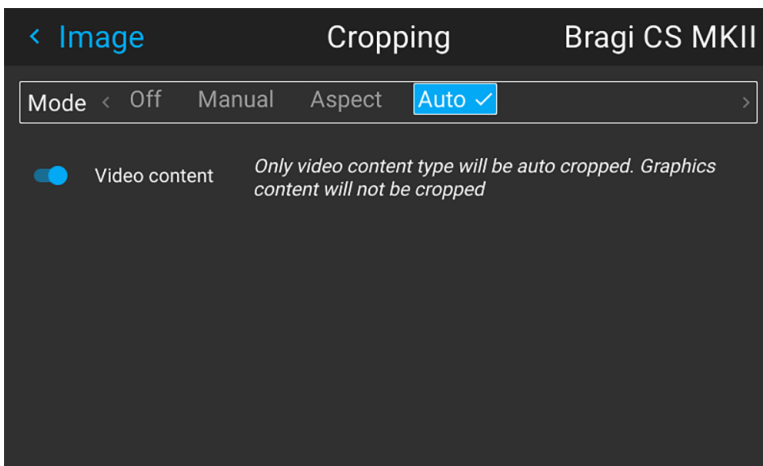

Image 7-4 Video content on

7.6 16:9 to center function

About

This function is available (and necessary) only for the 16:9 variant of the projector.

Must be used only in cases where the input format is 16:9, in combination with a Cinemascope screen. (2.35:1, 2.37:1, 2.39:1, 2.40:1)

The 16:9 to center functionality explained.

When a 16:9 content is projected on a Cinemascope screen, the lower and upper part of the picture will go outside the screen. (Overshoot).. When 16:9 to center function is enabled, the picture will downsize to fit the height of the screen. Therefore, in order to keep the aspect ratio, the image will not exploit the entire screen width.

How to enter the 16: to center function

Home/Image/Advanced settings/16:9 to center

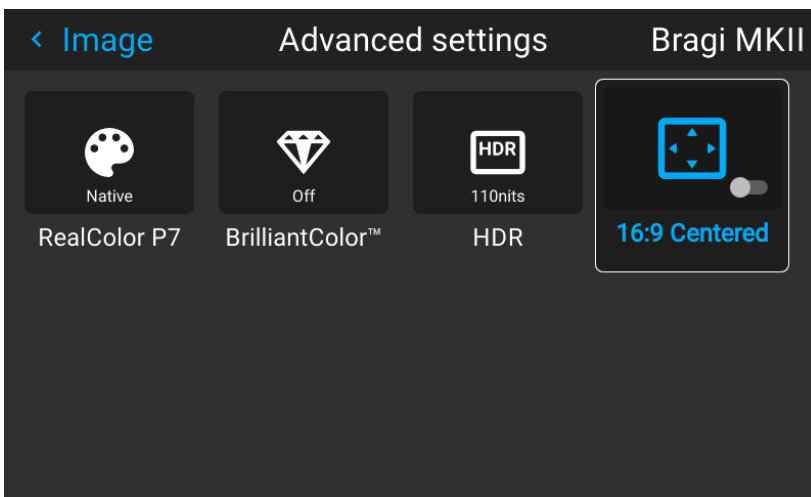

Image 7-5

Select this function by entering the menu path shown above.

Enter the slider switch to enable. The menu will show the status of the function, On of Off.

8

Installation menu

8.1	Lens	106
8.2	Orientation	109
8.3	Scaling modes	110
8.4	Warping	113
8.5	Blending	127
8.6	IG pixel shift	139

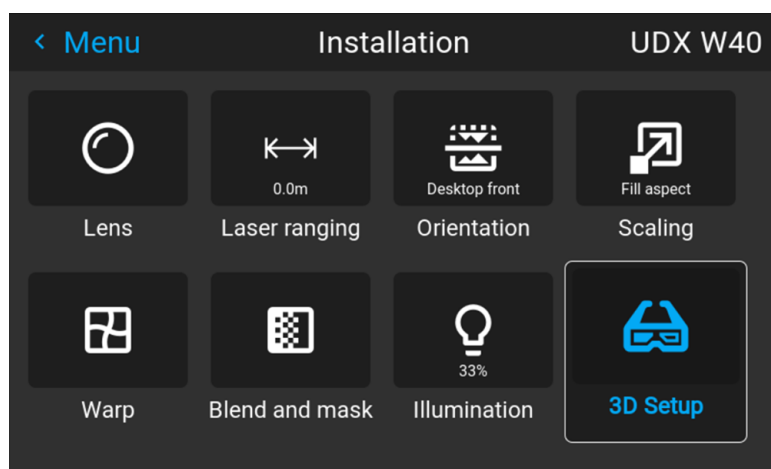

Image 8-1

8.1 Lens

8.1.1 Zoom / Focus

Zoom and focus

Enter the menu *Installation / Lens / Zoom Focus*

Use either the keypad arrows, or the remote control for this operation.

Use the navigational arrows, up and down, to adjust zoom.

Use the navigational arrows, left and right, to adjust focus.

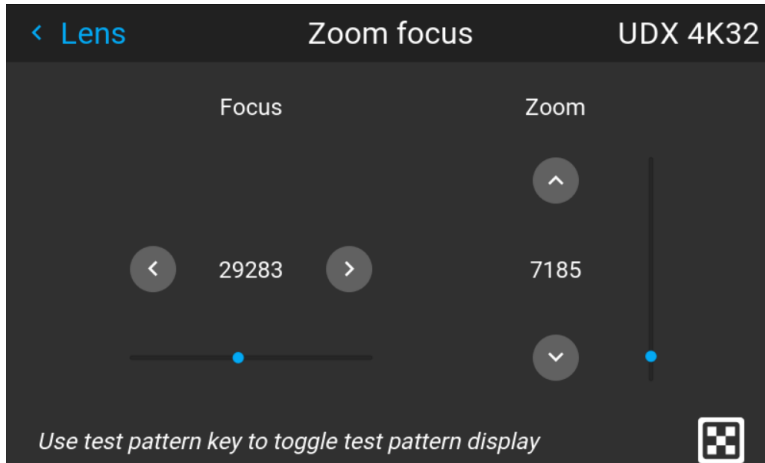

Image 8-2

General

Zoom controls the size of the projected image.

Focus controls the sharpness of the projected image.

Lens zoom and focus adjustments are motorized. You can use the remote control, local keypad, OSD and/or RS-232 commands to adjust the lens zoom and focus positions.



Not all lenses have zoom or iris control. The matrix below shows what controls are available per lens.

	E-N11	E-N12	E-N13	E-N14	E-N15	E-N16	E-N33	E-N41	E-N42	E-N43	E-N44	E-N45	E-N46	E-N47
Iris	✓	✓	✓	✓	✓	✓	✗	✓	✓	✓	✓	✓	✓	✓
Zoom	✓	✗	✓	✓	✗	✓	✗	✓	✗	✓	✓	✓	✓	✗
Focus	✓	✓	✓	✓	✓	✓	✓	✓	✓	✓	✓	✓	✓	✓

For best results, lens adjustments should be done in the following order: zoom, focus and then iris (where applicable).

8.1.2 Shift

General

The lenses can be shifted vertically and horizontally to facilitate precise image positioning in single and multiple projector systems. The projector allows for horizontal and vertical shift in both directions. Always place the projector perpendicular to the screen, and use the lens shift to align the picture.

Use the Remote control or the keypad on the Projector to adjust the lens shift mechanism.

Use the left, right, up and down navigational arrows to adjust the lens shift in four directions. This feature moves the picture optically within the shift range of the lens optics.

Press the right key to enable shift, and use the arrow keys on the remote control, or the keypad to move the picture in vertical and horizontal directions.

If not possible to align the projector perpendicular to the screen, due to environment of other, see chapter [“Warp – 4 Corners adjustment”, page 117](#)

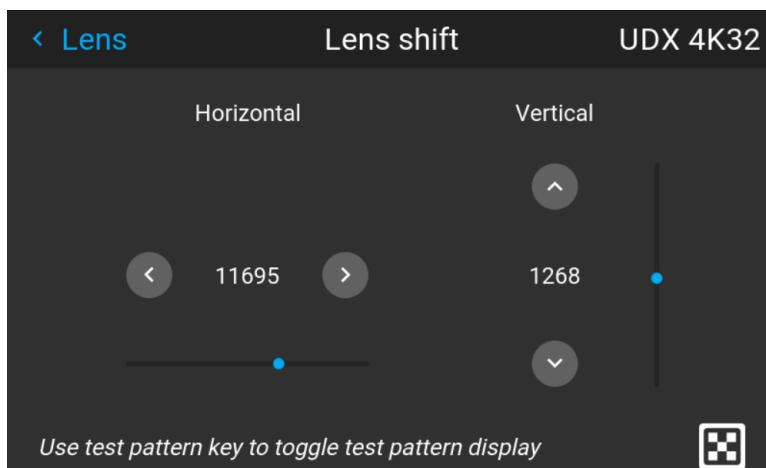

Image 8-3



When EN 68 lens is installed in the projector, there are some limitations in the lens shift range, in order to avoid damage to the lens. This limitation will be identified as an reduction in the output light from the projector when the shift position exceeds the defined range. The output light will then be reduced to 20% of max.

8.1.3 Shift to center

From remote control

This function adjust the lens position to the mechanical mid position.

Enter the *Menu/installation/Lens/Shift to center* menu.

Confirm with the ✓ button on the remote control, and the “Lens shift to center position?” pop up windows shows up.

Move the highlighted rectangle to “OK”, and confirm with the ✓ key.



When EN68 lens is installed:

Due to restrictions in light output for the EN 68 lens, the mid position for this lens will not be the mechanical mid position, but the mid position of the area where max light output is allowed.

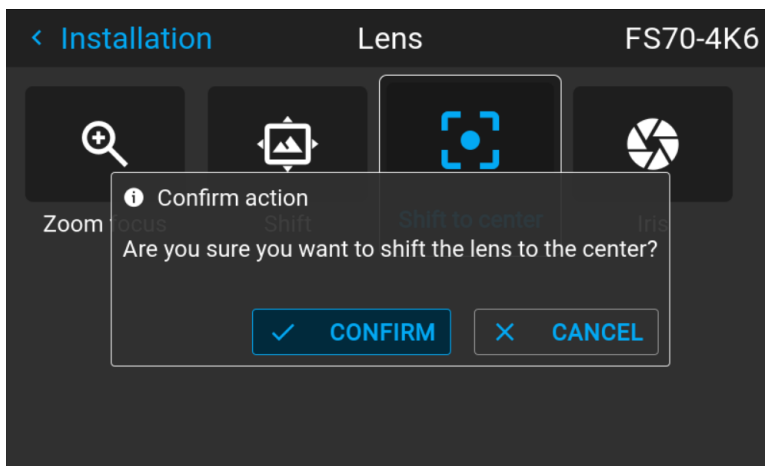

Image 8-4

From the keypad

Press the Lens button on the keypad. A menu picture as shown below shows up.

Press the ✓ button for 3 seconds.

8.2 Orientation

About

Menu/Installation / Orientation

Rotate the image on the imaging device depending on the physical installation of the unit.

There are four installation options, as illustrated below:

- Front/table
- Front/ceiling
- Rear/table
- Rear/ceiling
- Auto front
- Auto rear

Default: Table Front.

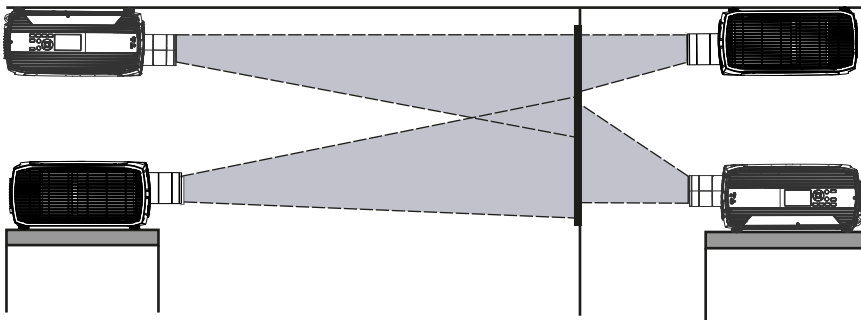

Image 8-5

How to set the correct orientation

Select Orientation from the menu

The orientation menu is displayed

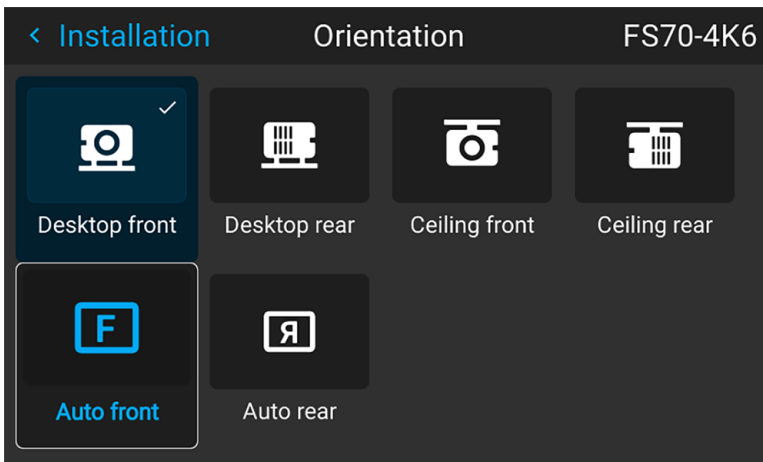

Image 8-6 Orientation Menu

Use the arrow keys to select the Mounting and Projection positions, and press OK button to activate.

The Auto front / rear will detect the orientation of the projector (desktop / ceiling), and is just an shortcut to the front / rear setup.

8.3 Scaling modes

General



For the modes Fill Screen and Stretch, the screen size must be defined, see chapter “Warping Screen Size”.

The purpose of the scaling mode is to adapt the image on the screen in an optimal way, based on the desired rendering. The examples below shows a screen format of 2,35:1, and a DMD format 16:10. (WQXGA).

The scaling mode function has four different presets:

- Fill aspect
- 1:1
- Fill Screen
- Stretch.

The illustrations below shows the resolution for WQXGA, and a screen aspect ratio of 2,35:1 (Cinemascope format). But the principle is the same also for other resolutions and screen sizes.(4K, WUXGA / 16:10, 16:9..)

Mode Fill aspect

This mode utilizes as much as possible of the native size of the DMD, and keeps the aspect ratio.

Input signal (Source): 4 : 3

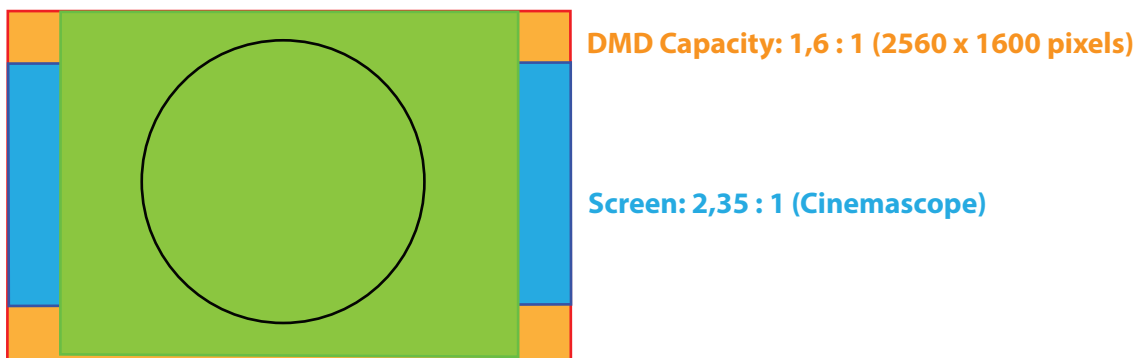

Image 8-7

1:1

This mode is an exact rendering of the source signal, pixel by pixel

Input signal (Source): 4 : 3

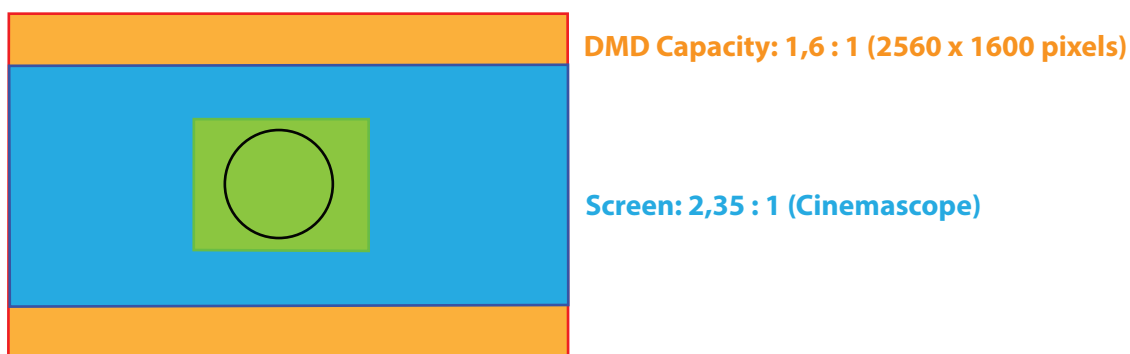
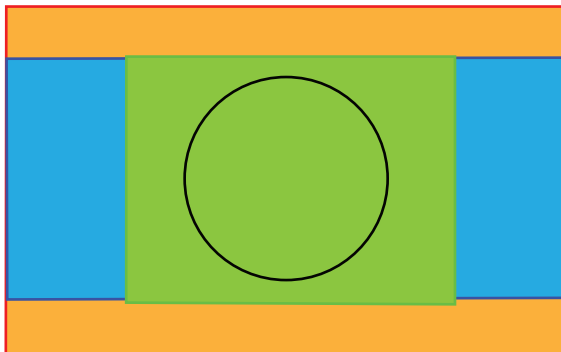

Image 8-8

Fill Screen

This mode utilizes the defined screen size, and keeps the aspect ratio.

Input signal (Source): 4 : 3



DMD Capacity: 1,6 : 1 (2560 x 1600 pixels)

Screen: 2,35 : 1 (Cinemascope)

Image 8-9

Stretch

This mode stretch the rendered picture to utilizes the defined screen size. The rendered picture will then be stretched / distorted compared with the source signal.

Input signal (Source): 4 : 3

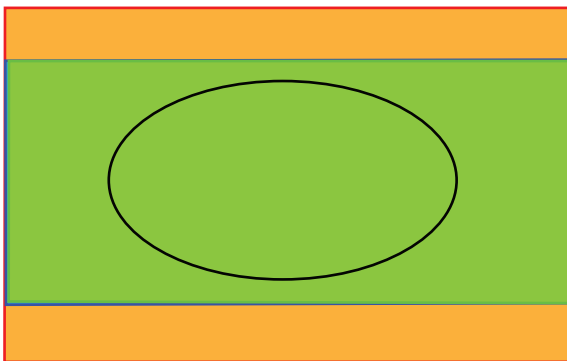

DMD Capacity: 1,6 : 1 (2560 x 1600pixels)

Screen: 2,35 : 1 (Cinemascope)

Image 8-10

How to enter.

Enter the *Menu/Installation/Scaling* menu.

Select the desired mode and press OK button on the remote control or keypad.

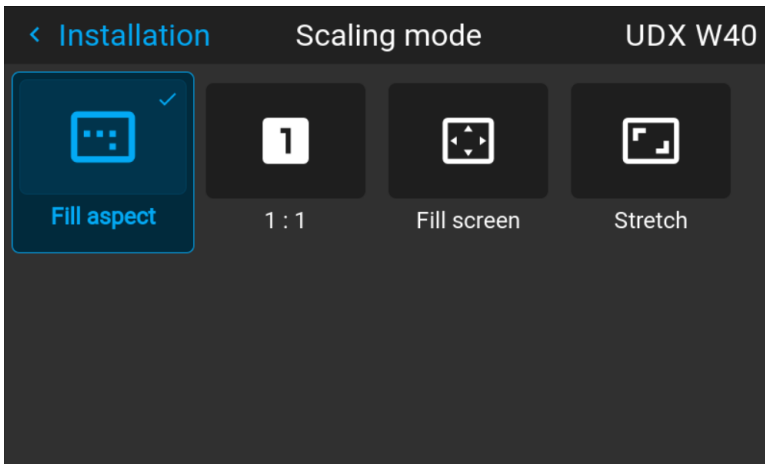

Image 8-11

8.4 Warping

8.4.1 About warping

About

Image warping is the process of digitally manipulating an image to compensate for the distortion of the screen, typically by non perpendicular alignment of the projector versus the screen. The image will then typically occur as shown in [Image 8–12](#).

While an image can be transformed in various ways, pure warping doesn't affect the colors.

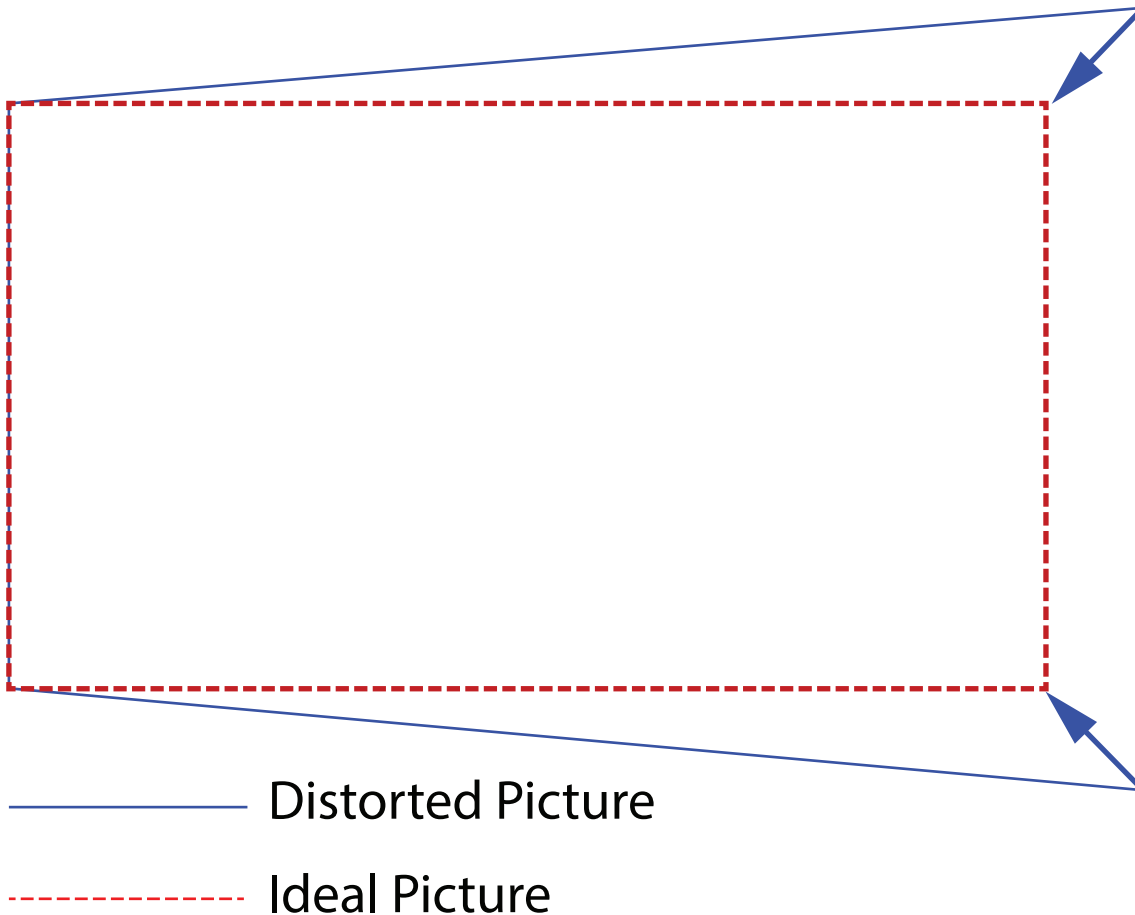

Image 8–12

8.4.2 Warping – On/Off

About warping on/off

By toggling between on and off the warping functionality can be enabled or disabled.

How to toggle

1. In the main menu, select *Installation* → *Warp*.

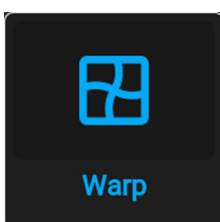

Image 8–13 Installation menu, warp

The Warp menu is displayed.

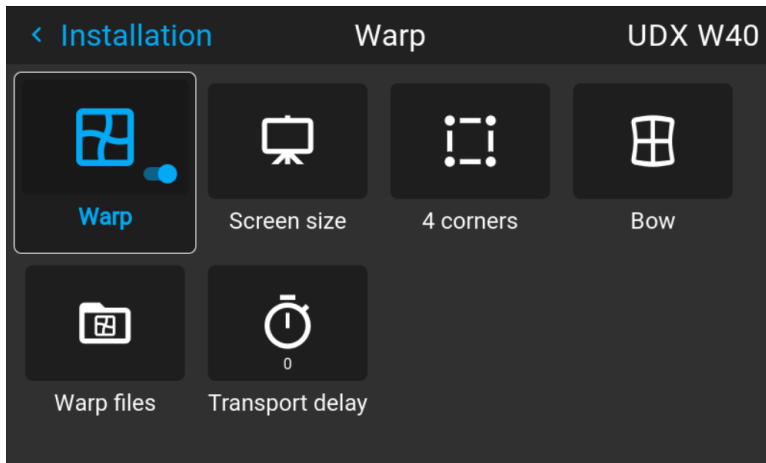

Image 8-14 Example of the Warp menu

2. In the Warp menu, click *Warp* to toggle between *On* and *Off*.

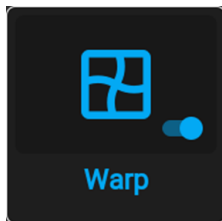

Image 8-15

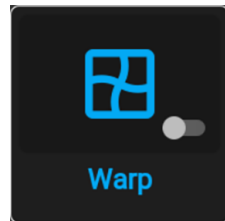

Image 8-16

8.4.3 Warping – Screen size

About (Warp) Screen Size adjustment

If the used screen aspect ratio is different than the projector aspect ratio, e.g. source is 16:9 and projector is 16:10, then black bars will be projected. In the example case a black bar on top and bottom of the image will be projected. The warp area contains not only the image information but also the black bars. If we want to position e.g. the active left top corner exactly on the screen using 4 corner warp, then it is very hard to do that as we are moving the black left top corner and we do not have control over the exact position of image left top corner. By moving the outline of the warp screen size to the active image information, the corner points of the warp area are now exactly on the corner points of the active image information and makes warping much easier.



Image 8-17 Warp outline example

How to adjust the image?

1. In the main menu, select *Installation/Warp/Screensize*.
The Screen Size menu is displayed.

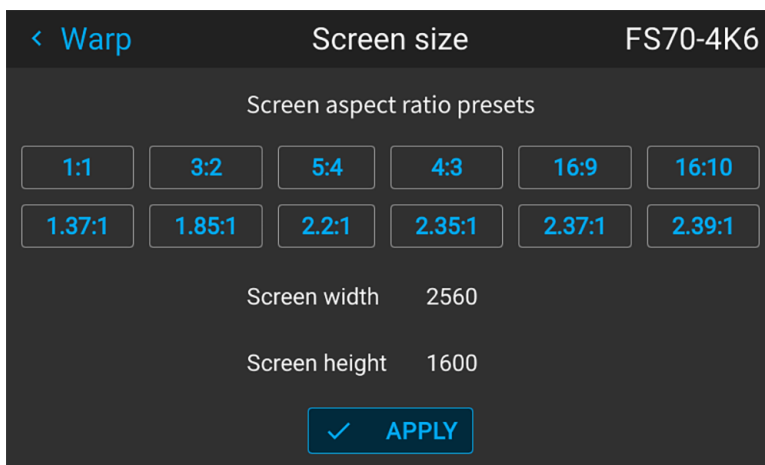



Image 8-18

2. Select the pre defined aspect ratio that suits the aspect ratio of the screen.
3. Set the screen size width and height to match the measurement of the screen.

 **Note:** It is only the ratio between the width and height that is used, so the values may be entered as the screen aspect ratio or actual measurement in cm, inches or any other unit.

Tip: A red border will be projected along with the current image. The border is a visual tool, showing the result of the adjusted outline.

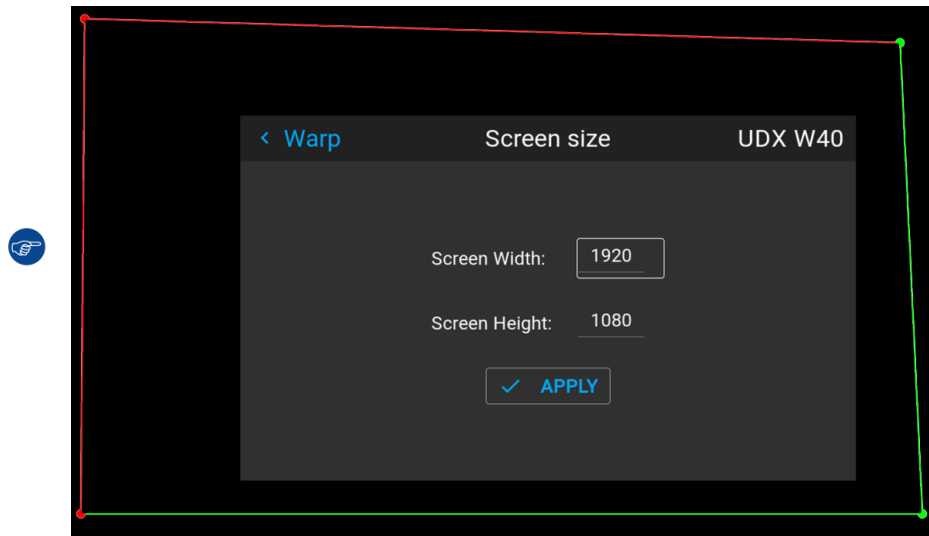

Image 8-19

Tip: The value can also be entered by the numeric keys on the remote control. Press * to delete existing numbers, and enter the new value by the numeric keys.

4. Click **Apply**.

8.4.4 Warp – 4 Corners adjustment

About 4 Corners adjustment

Basically, this type of warping adjusts each of the four image corners in the X and Y direction, if you have a typical trapezoid picture of the screen as shown below.

To have a successful Warp correction, the size of the screen must be entered. See “[Warping – Screen size](#)”, page 115

Some examples of pictures when the projector axis is not perpendicular to the screen.:



Image 8-20

How to adjust the image.

1. From the warp menu, select the menu *Installation/Warp/4 Corners*.
2. Select and enter the Helper lines slider. A yellow frame will be visible.
3. To enable the 4 Corners Warping, Set the Warp slider to the right position. (Select and enter).
4. Enable the corner that must be warped (Select and enter). If need for warping several corners, select and adjust the corners one by one.
5. Adjust the value by the arrow keys. The X value is adjusted by the left/right arrows on the remote control, and the Y value is adjusted by the up/down arrow in the remote control. The value represent the movement of the X and Y coordinates for each corner. When the warping is complete, exit the menu by using the “Back” button.

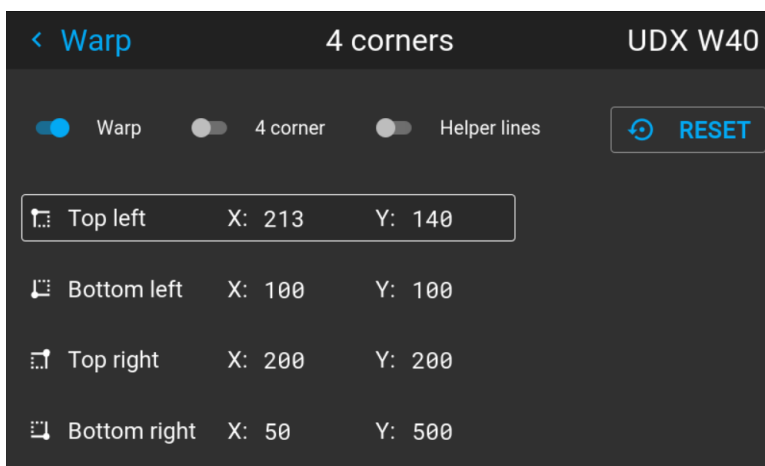

Image 8-21

6. If the picture still has a trapezoid shape, warp is not enabled. Select the *Installation / Warp* menu, and press enter. The slider moves to the right, and the warp status changes to “On”.

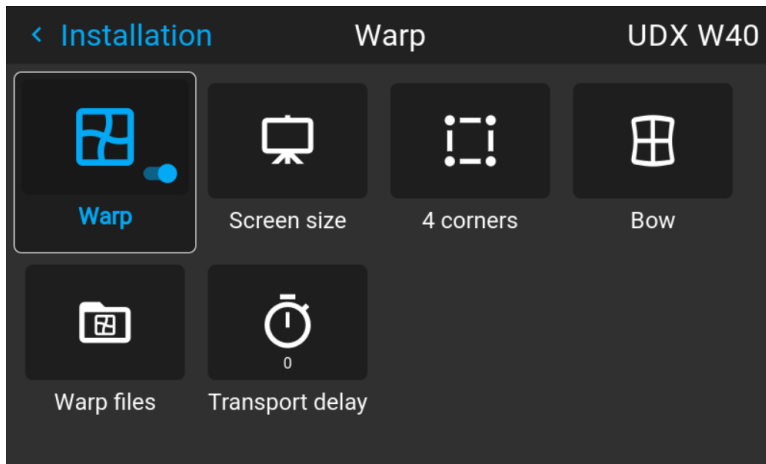

Image 8-22

8.4.5 Warping – Bow

About bow adjustment

A bow distortion can be adjusted so that a normal image is displayed. Positive adjustments angles introduce more outside bow distortion. Negative adjustments introduce more inside bow distortion.

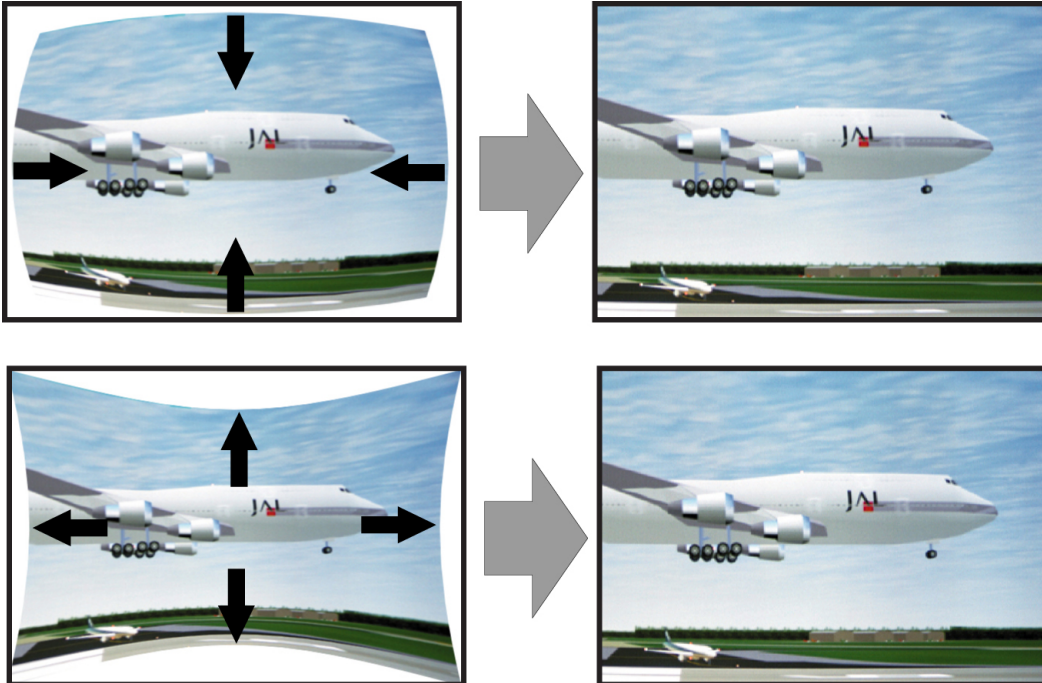

Image 8-23 Bow distortion

Symmetric bow correction

1. In the main menu, select *Installation/Warp*.

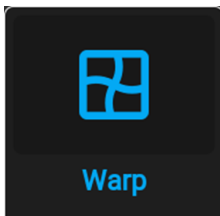

Image 8-24 Installation menu, Warp

2. In the Warp menu, select *Bow*.

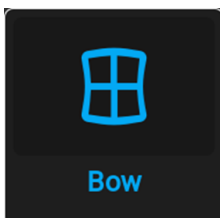

Image 8-25 Warp menu, Bow

A check symbol at the bottom right corner indicates that the bow function is activated.

When the bow menu is selected, a grid will occur in the screen picture in order to visualize the adjustments performed.

3. To enable Bow correction, make sure the *Bow* slider is set to *On*.
The slider is enabled when set to the right and when it is highlighted blue.

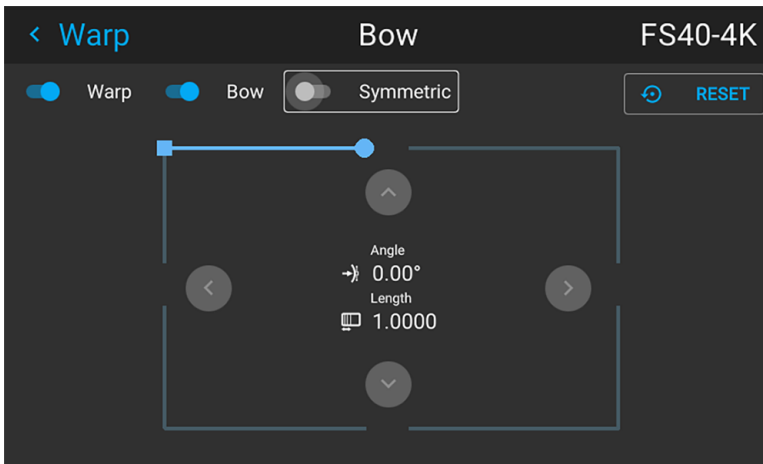

Image 8–26 Symmetric Bow correction.

4. To enable a symmetric adjustment, make sure the *Symmetric* slider is set to *On*.

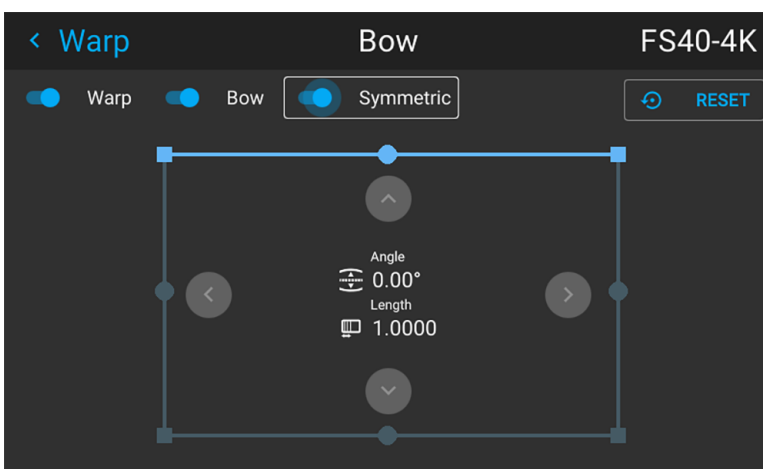

Image 8–27

The slider is enabled when set to the right and when it is colored blue.

5. Select the side of the picture to be bow corrected, confirm by pressing enter, and use the arrow keys to adjust the angle and linearity (length) of the vectors.

The angle is adjusted by the up and down arrows on the remote control, and the linearity is adjusted by the left and right arrows.

The correction will occur symmetrically on each side of the center of the highlighted side.

When corrected with the values in the image above, the picture will occur as shown below.

Repeat this step for all sides of the picture that has to be corrected.

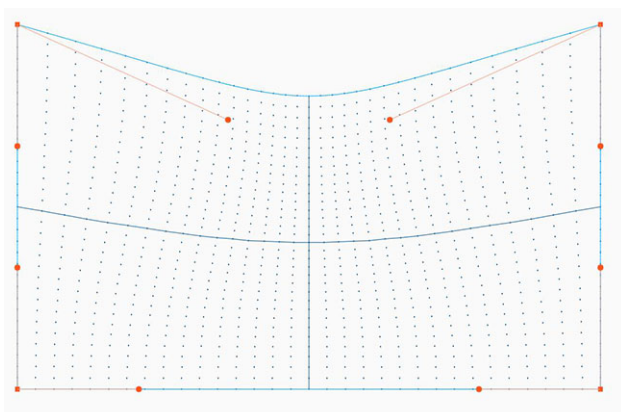

Image 8–28 Symmetric bow corection

Non symmetric bow correction

1. Enter the Bow menu, and disable the symmetric slider.
2. There are now two vectors on each side of the picture that can be adjusted individually. Select each of them, and adjust angle and linearity (length) individually to obtain the correct correction.

The angle is adjusted by the up and down arrows on the remote control, and the linearity is adjusted by the left and right arrows

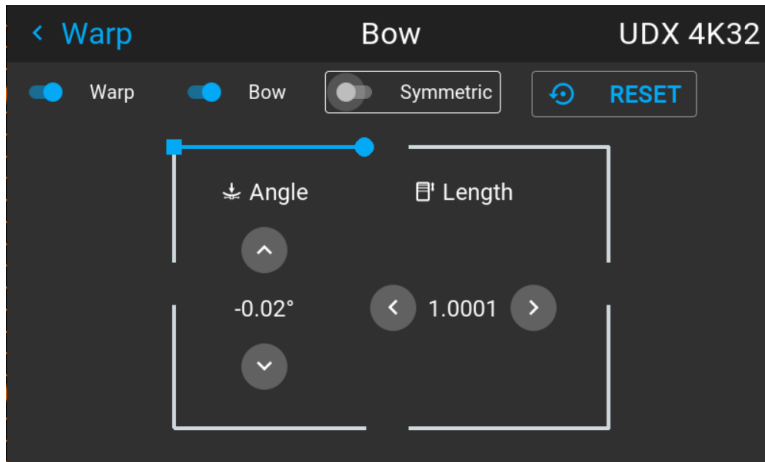

Image 8–29 Left vector of the upper side of the picture.

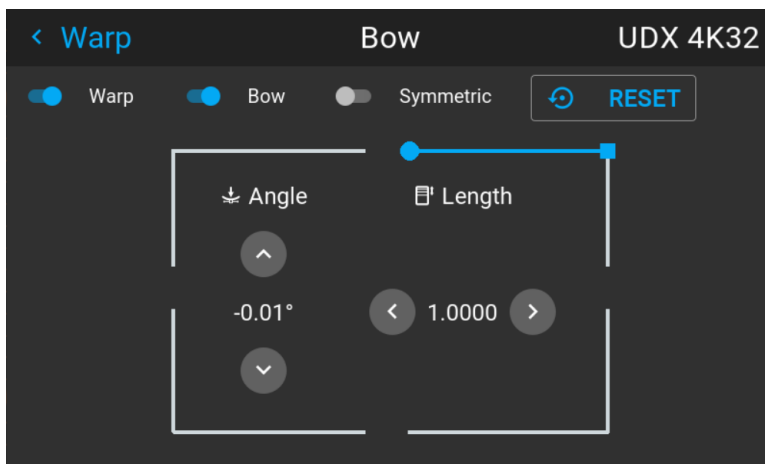

Image 8–30 Right vector of the upper side of the picture.

3. When corrected with values in the illustrations above, the picture will occur as shown below. Observe that the upper side of the picture now has an asymmetric correction.

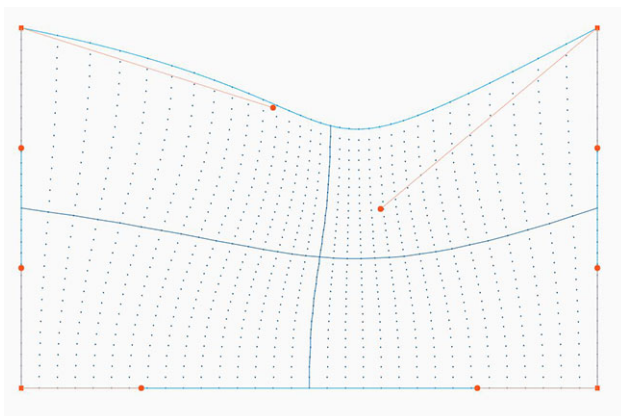

Image 8–31 Asymmetric bow correction

4. Repeat the step for each side of the picture that must be corrected.

Definition of angle and linearity (length) in the bow warp procedure

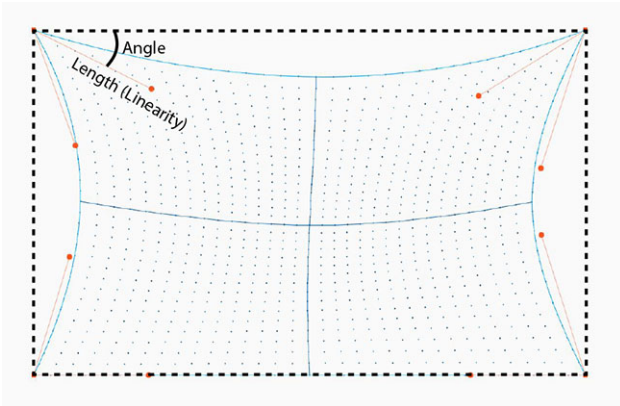

Image 8-32



To reset the bow adjustments, select *Reset* and press the **OK** button.

8.4.6 Warping – Warp files

About custom Warp Files

Next to setting your specific warp configuration in the GUI, you can also upload or download a custom warp grid in XML format to/from the projector. This is a time-saving option when multiple projectors need an identical Warp configuration.

To upload or download warp files you can use Projector Toolset or Prospector tool to upload/download the warp grid in the format of an XML file. Alternatively, you can contact the “file endpoint” directly via the curl program or some other tool that supports http upload.

For more information on uploading/downloading Warp files using the Projector Toolset, refer to the Projector Toolset user manual.

For more information on uploading/downloading Warp files using curl or other tools that supports HTTP upload, refer to the Pulse API Reference Guide.



When uploading a warp file that is too big, or with warp parameters outside the limits of the projector, some irregularities can occur. It will show up in two ways:

1: No warp enabled, picture still unwarped.

2: Distortions and artifacts in the edges of the picture.

There will be no error messages or warnings in the display when this occurs. The above mentioned symptoms is the only indication of this case.

How to activate an uploaded Warp grid?

1. In the main menu, select *Installation* → *Warp*.

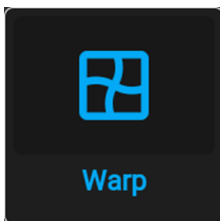

Image 8–33 Installation menu, Warp

2. In the Warp menu, select *Warp files*.

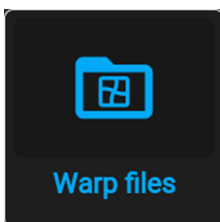

Image 8–34 Warp menu, Warp files

The Warp Files menu is displayed.

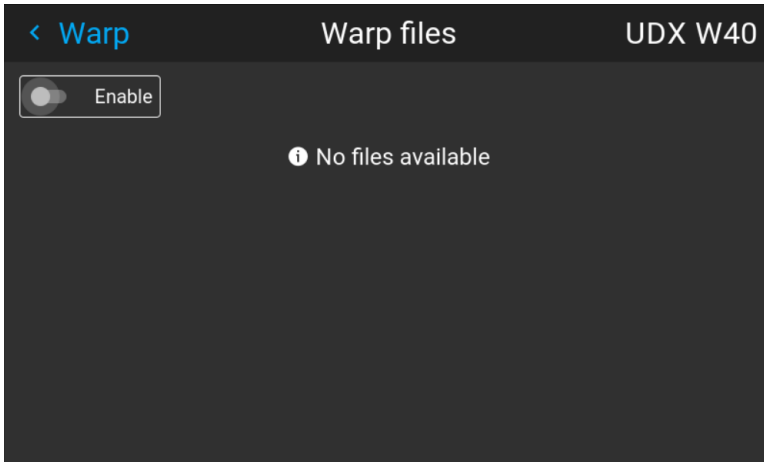

Image 8-35 Example of the Warp files menu

3. Make sure the Enable slider is set to right.
4. Select the desired warp file.

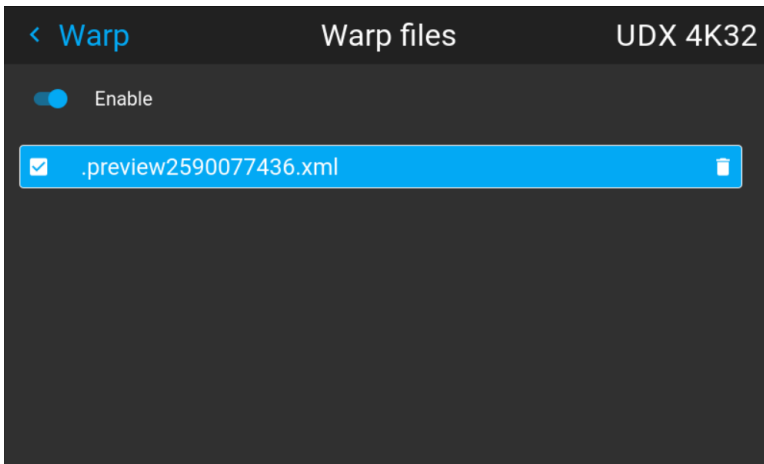

Image 8-36 Example of the Warp files menu

8.4.7 Warping – Latency control in a multi projector setup



Transport latency

The added delay in the image processing chain. The value is the number of lines relative to the output resolution.



Latency

The total time from the first pixel is coming in on an input source, until the first light representing that pixel is visible on the screen. This includes the transport delay. The value is normally given in milliseconds.

Functional description

Every projector in a multi-projector setup will have a different latency. This latency depends on the amount of warp and on the frequency of the projected image. In order to have no visible difference in the overall projected image, the user needs to be able to control the latency of each projector.

The latency value can be read out in the status menu for each individual projector.

How to configure transport delay?

1. Read out and note the latency of each projector in the multi-projector setup. You can find this latency under **Transport delay** in the status menu for each projector.

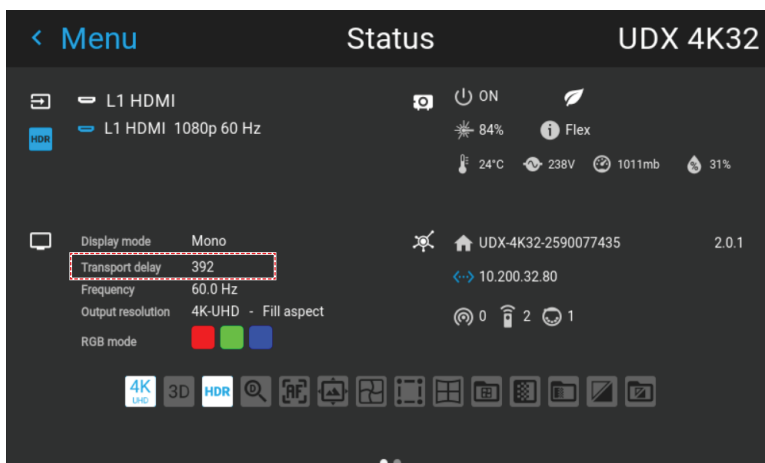

Image 8–37 Example of the Transport delay in the status menu

2. Identify the projector with the longest delay.
3. For each projector in the setup, select *Installation* → *Warp* in the main menu.

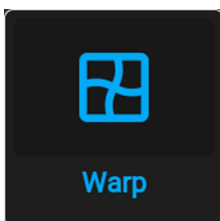

Image 8–38 Installation menu, Warp

4. In the Warp menu, select *Transport Delay*.

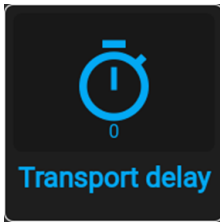

Image 8–39 Warp menu, Transport delay

The Transport menu is displayed.

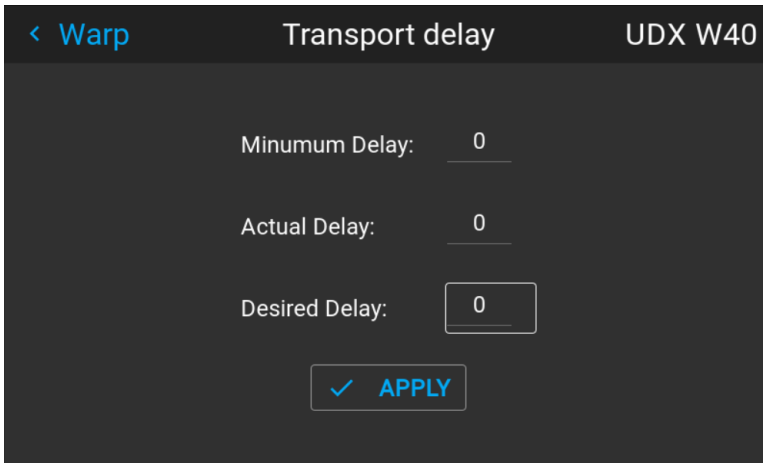

Image 8–40 Example of the Transport delay menu

5. Enter the value either by the arrow keys (one step at a time) or directly by the numeric keys on the remote control.
6. Click “Apply” to confirm the value.
7. Repeat this process for every projector in the setup.

8.5 Blending

8.5.1 Introduction to blend functions

When to use blend functions

When two projectors are used together to make one picture on the screen, the blend function must be activated. This blend function ensures a seamless transition of the images between the two projectors.

The principle is that the light intensity in the blend zone from each projector will be adjusted individually, so that the rendering on the screen are perceived as from one projector.

The blend function can be enabled for both pictures over/under, and pictures side by side.

The blend will not be affected by the projector's warp.

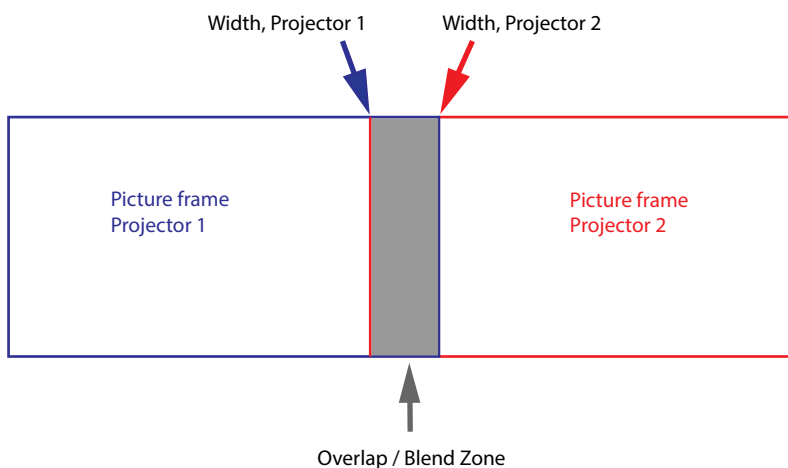

Image 8-41

The Mask adjustments.

The offset adjustments are used to cut the image on each side. Normally used to hide parts of the picture that shall not be shown on the screen. An example can be: If the source is a pc, you may want to hide the menu bar at the bottom of the screen.

8.5.2 Set up the system

How to set up the system

In this chapter, the setup procedure for the projectors is explained, but a setup procedure must also be performed for the picture source.



In order to obtain a satisfying result for the Blend function, the overlap / Blend zone are recommended to be at least 10% of the picture width.

The basic principle is that the overlap setup in the source shall correspond with the blend width setup for the projector. That means that if the overlap zone for the source is set to 500 pixels, the width of the blend zone for the projector also must be set to 500 pixels.

First step is to align the image from the projectors as accurate as possible in a mechanical way, meaning without any optical corrections. At the same time, establish an overlap in the pictures between the two screens.

Then adjust the remaining irregularities by using the shift and warp features in the projectors to obtain the last fine tuning of the alignment.

Setup the source to a blend which corresponds with the preset overlap on the screen. There are different ways to do this, depending on the source. Refer to the source unit's manual for this issue.

Adjust the Blend for the projectors as described below.

8.5.3 Blend mask setup procedure

Blend mask introduction

The blend mask function blends out an area on the outer edges in the picture. This function is applicable when e.g. icons in the toolbar in an image from a pc is to be projected.

The blend mask area will be defined in the blend mask setup process.

Blend mask adjustment procedure

1. Enter the menu *Installation/Blend/Blend mask*

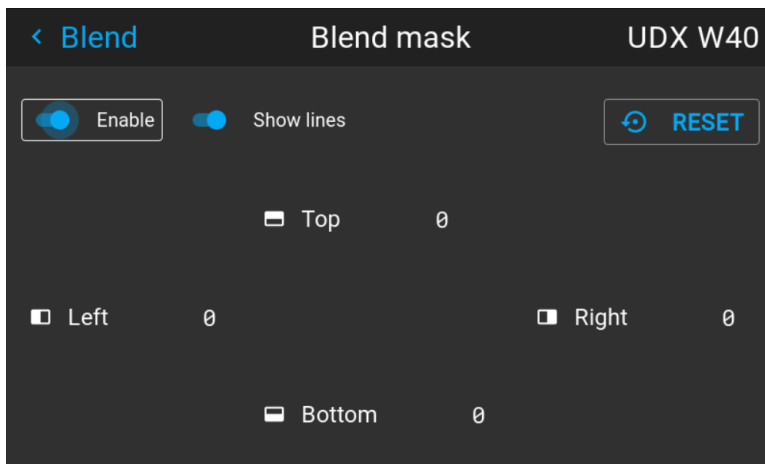

Image 8-42

2. By the arrow keys, place the display cursor on respectively the "Enable" zone and the "Show Lines" zone and activate them by pressing enter.
3. Use the arrow keys to move the cursor to the position that must be masked. and press enter.
4. Adjust the mask area (width) by pressing the arrow keys on the remote control. By pressing the key arrow constantly, the blend value will increase rapidly. The numeric value of the width is shown on both the LCD screen and the OSD. (The number entered represent the blend width expressed in number of pixels).
5. Use the enter key to move the cursor to the next position that has to be masked.

6. Adjust the value by using the arrow keys. (See note below).
7. Repeat step 4 and 5 to adjust the rest of the blending zones.
8. Exit the menu by using the exit button on the remote control.

8.5.4 Basic blend setup procedure

Basic blend adjustment procedure

Entering the Basic blend Adjustment from the *Menu/Installation//Blend and mask/Basic blend* menu, either by the remote control, or the keypad on the projector.

The “Enable” button enables/disables the blend function. The “Show Lines” enables alignment lines on the screen, in order to visualize the overlap/blend zone.

Use the up/down/left/right arrow key on the remote control or key pad to navigate in the menu.

Basic blend introduction

The basic blend function introduce an gradual transition of the light intensity between the edge of the picture and the line defined in the basic blend setup process.

When a blend mask is introduced, the gradient will start from the defined edge of the blend mask.

Basic blend adjustment procedure. Side by side configuration.

1. In the menu select *Installation/Blend/Basic blend*. The Basic blend menu is displayed.

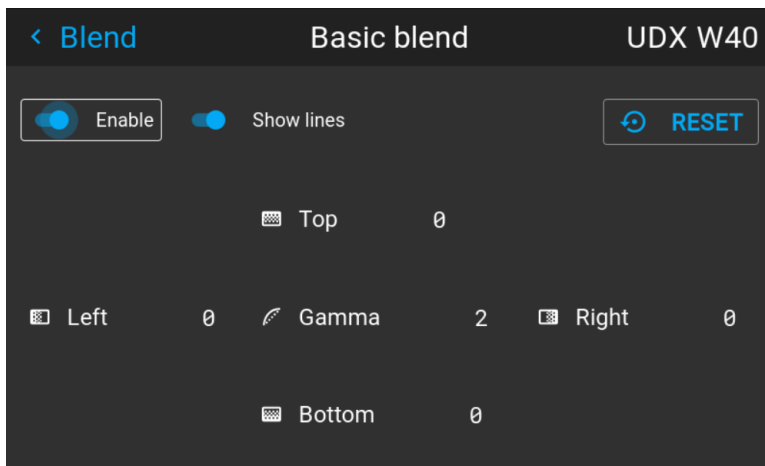

Image 8–43

2. Starting with the left picture: By the arrow keys, place the display cursor on respectively the “Enable” zone and the “Show Lines” zone and activate them by pressing enter.
3. Use the arrow keys to move the cursor to the position that must be blended. and press enter.
4. Adjust the width value by using the arrow keys (See note below), one step at a time. By pressing the key arrow constantly, the blend value will increase rapidly. The numeric value of the width is shown on both the LCD screen and the OSD. (The number entered represent the blend width expressed in number of pixels).
5. Use the enter key to move the cursor to the next position that has to be blended.
6. Adjust the value by using the arrow keys. (See note below).
7. Repeat step 4 and 5 to adjust the rest of the blending zones.
8. Exit the menu by using the exit button on the remote control.



For horizontal blending, use the left/right arrow keys to adjust.
For vertical blending, use the up/down arrow keys to adjust.

Adjustment procedure in over / under configuration.

For Blend adjustments in over / under configuration, the procedure is the same as for side by side, but use the Top and Bottom height instead, and perform a similar procedure.

Use the numeric keys instead of the arrow key to set the values.

Instead of adjusting the lines by the arrow keys, the value can also be typed directly using the numeric keys on the remote control.

To remove or undo the entered numbers, use the * key on the remote control.

8.5.5 Black level setup procedure

Black level introduction

The Purpose of the black level adjustment is to adjust the black levels in the non overlapped areas with the black level in the overlapped areas (Blend Zone).

This is a necessary function, due to the fact that the black level will be brighter in the blend zones, since multiple projectors will add light in these zones.

The width of the black level area shall ideally be slightly larger than the width of the blend zone in order to also compensate for the “sea of mirrors” phenomenon.

The figure below shows how this occurs in a side by side configuration without any correction of the black level.



Image 8–44

Black level adjustment procedure

1. Select the menu *Installation/Blend and mask/Black level*.
2. Enable the “Black level” and “Show lines” buttons. A line that indicates the blend zones will be visible on the screen when “Show lines” is enabled.

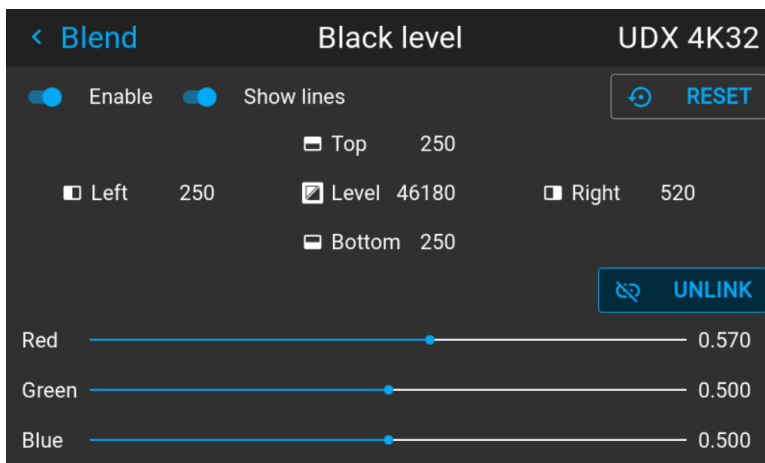

Image 8–45

3. Move the cursor to the side where the overlapped area occurs. (Left/right/top/bottom.) For the left projector, this will typically be the right side in the menu as an example.
4. Press enter, and adjust the value with the arrow keys. The icon shown below will appear on the OSD when the side is selected. The value shall typically be the same as for the basic blend line. (Same numeric value).

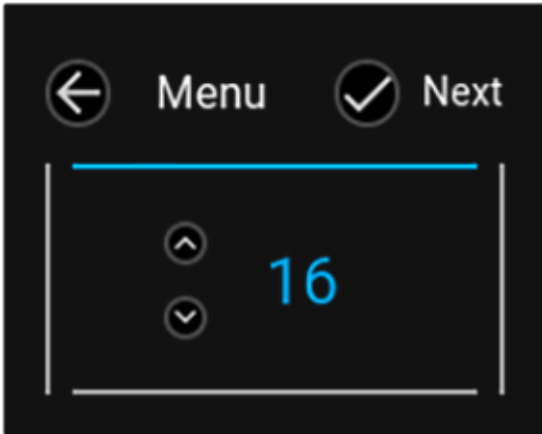



Image 8-46

5. When the value is ok, press enter on the remote control, and the icon on the OSD will jump to the next side. Adjust, and repeat for all sides.
6. When all sides are completed, press “Back” button on the remote control.
7. Move the cursor to “Level”, press enter and adjust this level until the black level equals the level in the blend zone.
 -  *Note:* In addition to the black level itself, it is also possible to adjust the color saturation in order to align the projectors in the layout, see procedure “Adjusting the color level” below.
8. Repeat the same procedure for the other projector,
9. Disable the “Show lines” when the Black level adjustment is completed.

8.5.6 Color level adjustment procedure

Color level introduction

When using several projectors in a complete setup, there will always be a slightly difference in the color saturation between the projectors. This is not visible

The purpose of black level correction is to ensure a uniform black level in multi projector setups. Even when two projectors are of the same type, different projectors will output slightly different colors for black due to minor variations in their optical components. So if the projected image of the projectors overlap, there will be 3 different black levels: one for the zone where only the picture of the left projector (zone 1), one for the Blend zone (zone 2), and one for the zone where there is only the picture of the right projector (zone 3).

Picture Left

Blend Zone

Picture Right

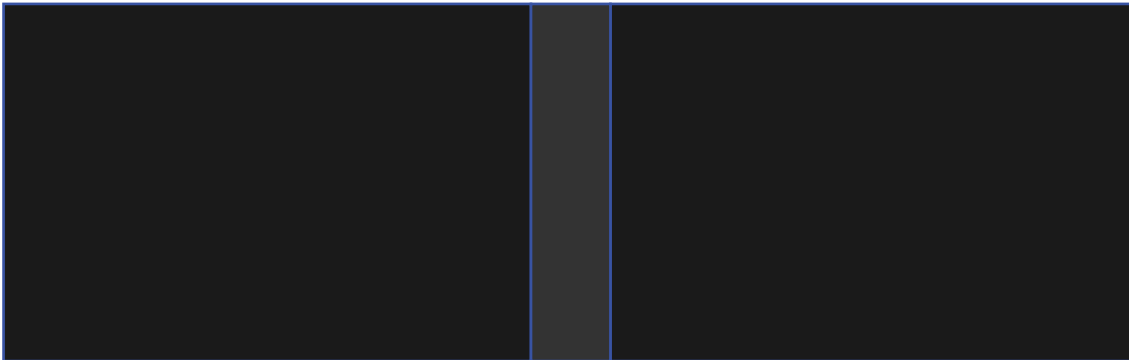

Image 8-47

How to perform an RGB adjustment

1. In the main menu, select *Installation / Blend and mask / Black Level* for all projectors in the setup. The Black level menu is displayed, containing the sliders for color adjustment.
2. Use “black” test picture for the projectors.
3. Observe manually the color saturation from each projector unit, and identify the difference.
4. If one projector, as an example, has more red in the test picture, select the red slider in the black level menu for this projector and adjust the slider with the arrow keys to obtain a similarity in the rendering.
5. Repeat for every projector and color until the desired result is achieved on screen.

8.5.7 Black level files

Black Level Files introduction

Next to setting your specific Black Level Adjustment in the GUI, you can also upload or download a custom Black Level adjustment file in png, jpeg or tiff format to/from the projector.

To upload or download Black Level masks you can use the Prospector tool. Alternatively, you can contact the “file endpoint” directly via the curl program or some other tool that supports http upload.

For more information on uploading/downloading Black Level files using the Prospector, refer to the Prospector user manual.

For more information on uploading/downloading Black Level files using curl or other tools that supports HTTP upload, refer to the Pulse API Reference Guide.

How to activate an uploaded Black Level adjustment file?

1. In the main menu, select *Installation / Blend and mask / Black level files*

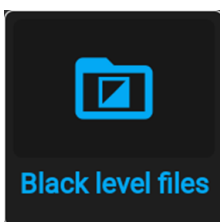

Image 8–48 Blend menu, Black Level Files

The Black Level Files menu is displayed. Files will be listed in this window

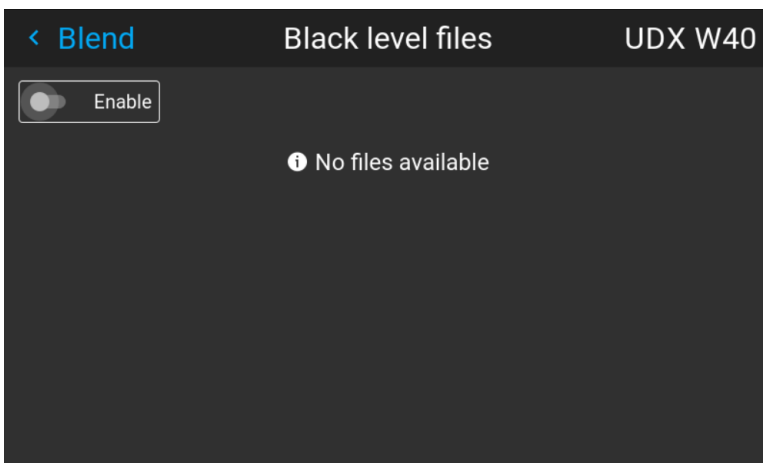

Image 8–49

2. If any custom Black Level adjustment files are available, select the desired file.
3. Click on the on/off button on top to activate the selected Black Level adjustment file.

8.5.8 Blend files

Blend files introduction

Next to setting your specific Blending configuration in the GUI, you can also upload or download a custom Blend configuration file in png, jpg or tiff format to/from the projector. This is a timesaving option when multiple projectors need an identical blending configuration.

To upload or download Blend masks you can use the Prospector tool.

Alternatively, you can contact the “file endpoint” directly via the curl program or some other tool that supports http upload.

For more information on uploading/downloading Blend files using the Prospector, refer to the Prospector user manual.

For more information on uploading/downloading Blend files using curl or other tools that supports HTTP upload, refer to the Pulse API Reference Guide.

How to activate an uploaded Blend configuration file?

1. In the main menu, select *Installation / Blend and mask / Blend files*

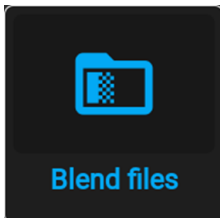

Image 8–50 Blend menu, Blend Files

The Blend Files menu is displayed.

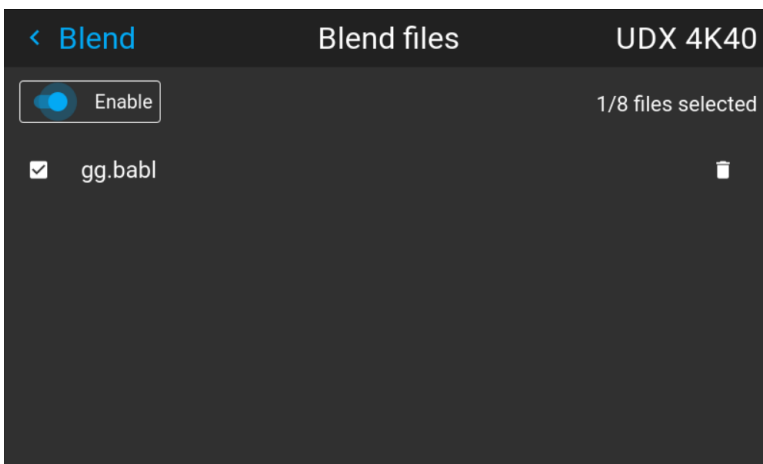

Image 8–51

2. If any custom Blend files are available, select the desired file.
3. Click on the on/off button on top to activate the selected Blend file.

8.5.9 Advanced blend

Description

The Advanced Blend Function is intended for blending in complex shapes in multiprojector installations.

Due to the complexity, a separate manual has been prepared for this subject, and can only be performed by an authorized installer. There is no user interface for this function.

8.5.10 CLO — Constant light output

CLO introduction

This function will ensure that the projector adjusts its illumination power to maintain the same level of output light during the lifetime of the light source. This requires that the LED power is not set to 100% from the start, but to a lower value. The lower this value is set, the longer the projector will manage to maintain the level. This is due to the fact that the light source has a naturally decreasing intensity over time.

How to set the CLO

1. Enter the menu *Installation/Illumination*

Note:



The CLO feature is not designed to compensate the Iris adjustment. This means that if the CLO is set, and the Iris is adjusted, it will affect the output light.

The illumination menu shows up

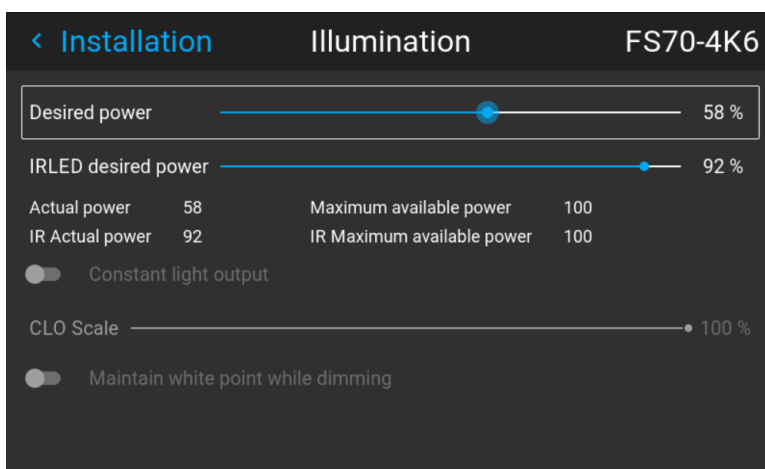

Image 8-52

2. Set the desired power slider to an appropriate value, see “”, .
3. Select the CLO button in the menu by the arrow keys on the remote control, and activate by pressing enter.

The output power will now remain constant

CLO scale slider

When the CLO button is enabled, the Desired power slider will be disabled, and by that not possible to adjust.

But if there is a short term need for further reduction of the output power, the CLO Scale slider can be used. The output will then be reduced with a percentage in relation to the desired power value.

E.g.; if desired power is set to 80%, and CLO scale is set to 50%, the output power will be 40% of max.

This will enable the users to calibrate luminance, and not only laser power in both single and multi-channel setup. This enables the CLO to maintain and adjust the light output. In multi-channel setup this make it possible to be able to dim the entire image using the same scale value on all channels.

This functionality is particularly useful for multi-channel installations. Only available through API commands, and is by that not accessible via the projectors User Interface.

8.6 IG pixel shift

About

All sub-menus, except from the IG Pixel shift, are described in other topics in this manual, where they more naturally belong.

8.6.1 IG pixel shift

General

IG pixelshift is a feature where the Image Generator can process the image in two channels.

This two input channels have different positions of the pixelshift module. Channel 1 is displayed with module position 1, and channel 2 is displayed with position 2. The result is a 4K rendering of the displayed image.

Max frequency per channel is 60 Hz.

Only DVI or Displayport inputs on the projector can be used for this purpose.

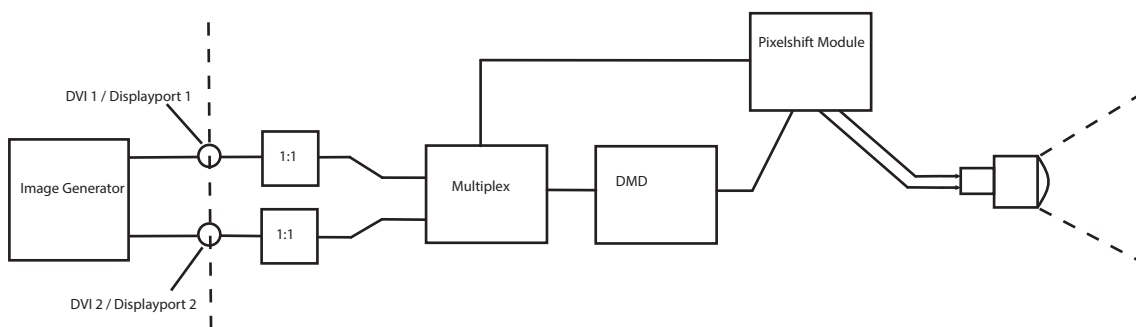

Image 8–53 IG Pixelshift. Principle of operation.

Preparations

Perform the necessary setup of the external image source. (Image Generator).

Connect to DVI 1/2 or Displayport 1/2.

Enable IG pixel shift

1. Enter the menu *Installation/ 3D setup*

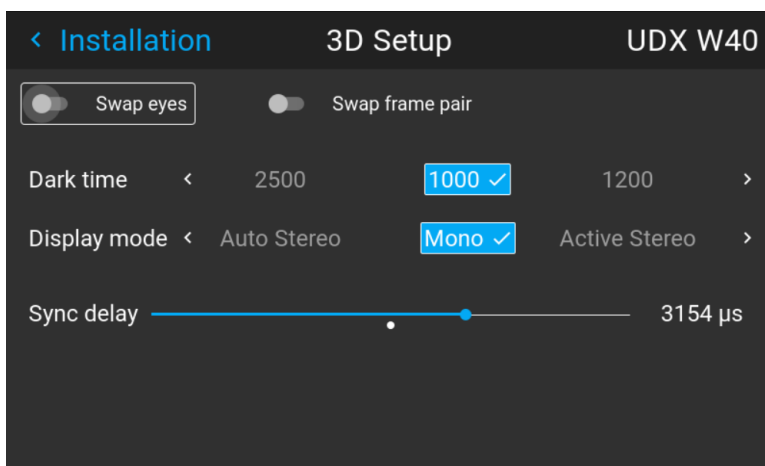

Image 8–54 Display setup Menu

2. Use the up / down arrow keys on the remote control to move the cursor to the “Display mode” position.
3. Use the left/right arrow key to scroll to IG pixelshift.
4. Select by pressing enter.

Status menu

When IG pixelshift is enabled, it will be visible in the Status Menu. (Scroll down a bit to see it), and also in the LCD Information display.

8.6.2 AutoStereo (3D) Setup

Enabling 3D mode

See chapter [“3D”](#), [page 169](#) for 3D mode setup

GUI – Profiles

9

9.1	Profiles introduction	142
9.2	Profiles setup parameters.....	143
9.3	Create new profile	145

9.1 Profiles introduction

About Profiles

The Profile function make it possible to store different profiles / projector setups for different use cases, and quickly recall them when needed. This means that there is not necessary to enter a lot of different menus to adjust the projector setup for different user cases.

As examples of different user cases are setup for video, gaming, different viewing environments and so on.

This is useful in installations where the projector are used for different purposes.

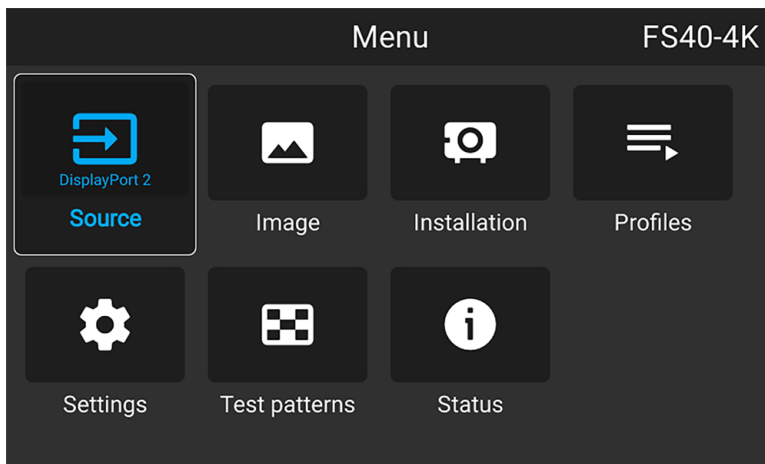

Image 9-1

9.2 Profiles setup parameters

Available profile settings

Area of interest	Settings
Source	Currently selected source
Image	<ul style="list-style-type: none"> • Brightness • Contrast • Gamma (Value and type) • Intensity • Saturation • Sharpness • Output resolution (e.g. 4K UHD, 4K UHD S or WQXGA on a WQXGA UDX) • Digital Zoom (Enabled status and factor) • Digital Shift (Enabled Status, X and Y)
PQ	<ul style="list-style-type: none"> • Screen luminance • HDR boost value
Realcolor	<ul style="list-style-type: none"> • Brilliant Color mode • P7 desired values • P7 measured values
Installation	<ul style="list-style-type: none"> • Lens parameters, if available (only valid if recalled with same lens) <ul style="list-style-type: none"> - Iris - Focus - Zoom • Lens shift (Vertical / Horizontal) • Motorized Frame parameters, if connected <ul style="list-style-type: none"> - Rotate - Tilt - Skew • Shutter position • Image orientation • Scaling mode
Warp settings	<p>Note: Only file-based warp supported via profiles</p> <ul style="list-style-type: none"> • Warp enabled status • Selected warp file • Transport delay
Blend	<ul style="list-style-type: none"> • Mask blend <ul style="list-style-type: none"> - Enabled status - Start and Width for each side • File blend <ul style="list-style-type: none"> - Enabled status - Selected files • S-curve ("gamma")
Black Level	<ul style="list-style-type: none"> • Mask Black level <ul style="list-style-type: none"> - Enabled status - Width for each side • File Black level <ul style="list-style-type: none"> - Enabled status - Selected file

Area of interest	Settings
	<ul style="list-style-type: none"> • R/G/B gain values
Illumination	<ul style="list-style-type: none"> • Illumination power for each source • CLO enabled status • CLO setpoint
Display	<ul style="list-style-type: none"> • Display mode (ActiveStereo, AutoStereo or Mono) • 3D settings <ul style="list-style-type: none"> - Dark time value - Swap Frame Pair On/Off - Sync Delay value - Sync Delay Invert On/Off

9.3 Create new profile

1. Adjust the necessary projector set up values for the actual user case as described in the specific topics in this manual.
2. Enter the menu *Profiles*

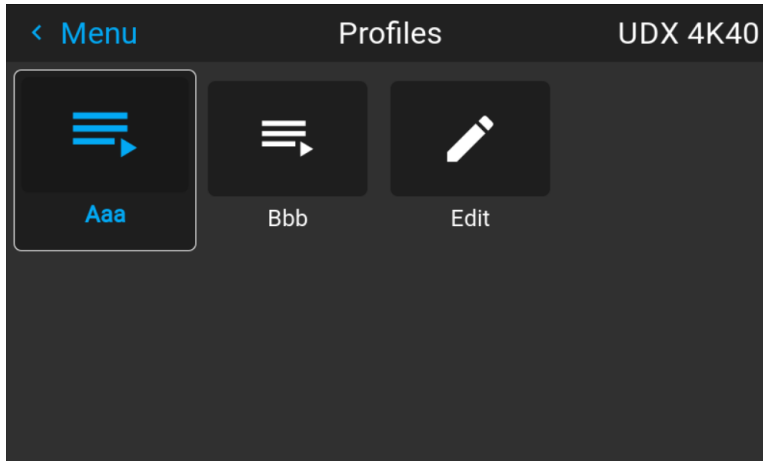

Image 9-2

3. Select the *Edit* button

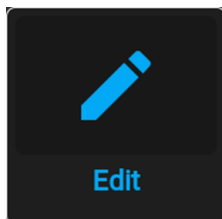

Image 9-3

The Profile edit menu shows up.

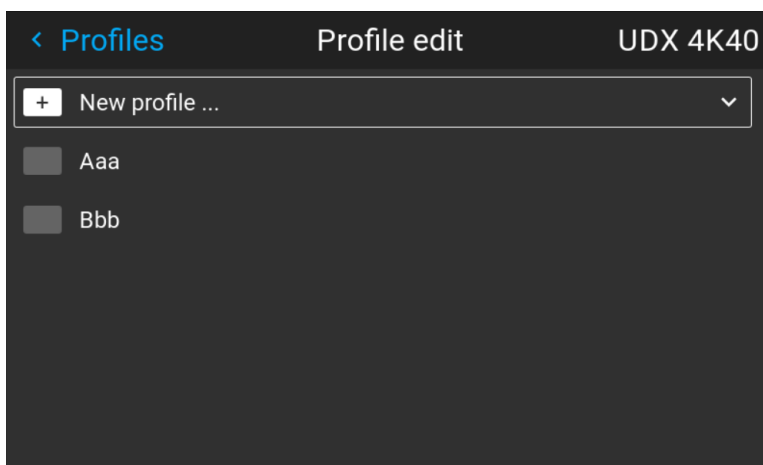

Image 9-4

4. Select New profile

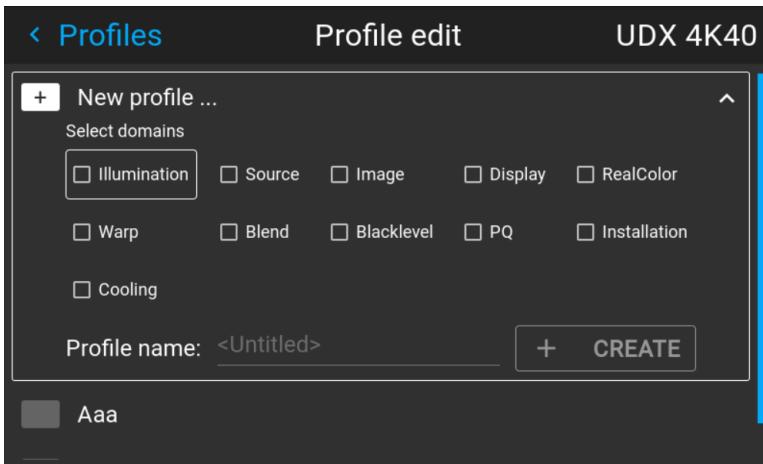



Image 9–5

5. Enter a suitable name for this profile via the pop up keyboard (arrow keys and OK (✓) to select). End the name entry by selecting the “return” key on the pop up keyboard.
6. Select the “Assign to preset slot”. A drop down menu will show up, select the preferred value.
 -  **Note:** The function “**Assign to preset slot**” enables a shortcut to the actual profile from the remote control. If assigned preset slot are set to 1, this profile can be recalled by pressing the key MACRO and then 01 on the remote control. It is not a requirement to use this function, just an option.
 -  **Note:** The maximum number of profile presets is 30.
7. Select the domains in the menu that shall be stored in the profile.

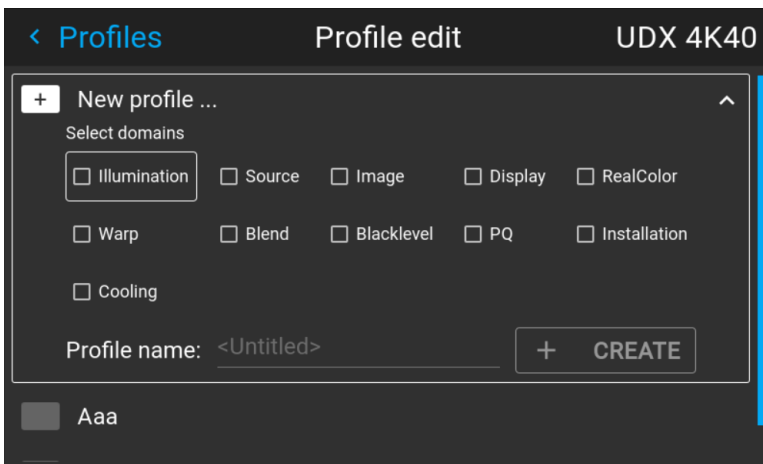

Image 9–6 Select domains

8. Select “Profile name”. A keyboard will show up, and enter a proper name for the profile.
9. Select “create” and confirm by the OK button.
 - The new profile is now created and saved.
10. Repeat step 1 to 6 for creating of more profiles.

Recall a profile.

1. Enter the *Menu/ Profile*
 - The stored profiles will be visible in the menu. Select the actual profile.

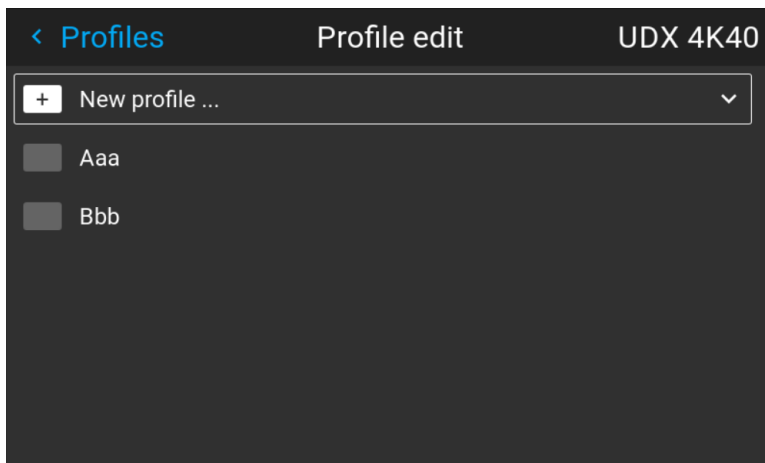

Image 9–7

or

Select the numeric shortcut from the remote control.

Edit a profile

1. Enter the *Menu/Profiles/Edit*
Select the profile to be edited.
2. Set, or change the “Assign to preset” number, or delete the actual profile. It is not possible to add or remove selected features in an stored profile. Must then be deleted, and a new profile must be created.

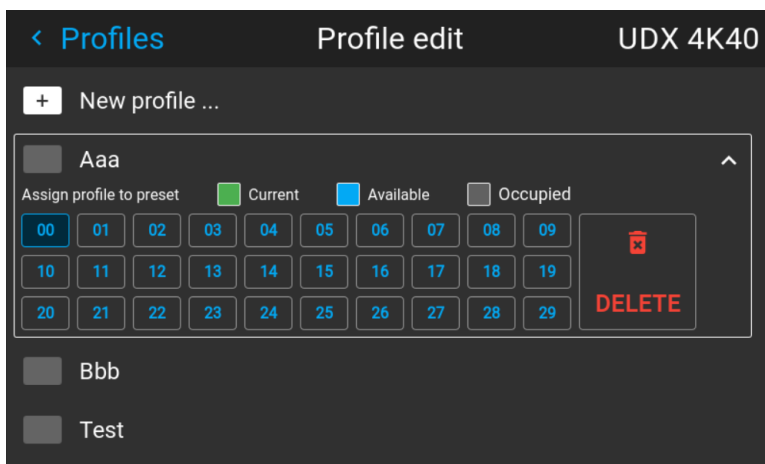

Image 9–8

System settings menu

10

10.1	Communication	150
10.2	IR control	151
10.3	Setting a custom projector name.....	154
10.4	Trigger.....	155
10.5	Language	156
10.6	Themes	157
10.7	Units.....	158
10.8	Backlight.....	159
10.9	Power settings.....	160
10.10	Lens features	161
10.11	Maintenance	162
10.12	Lens calibration	163
10.13	Controlling the backlight of the LCD Display.....	164

Menu overview

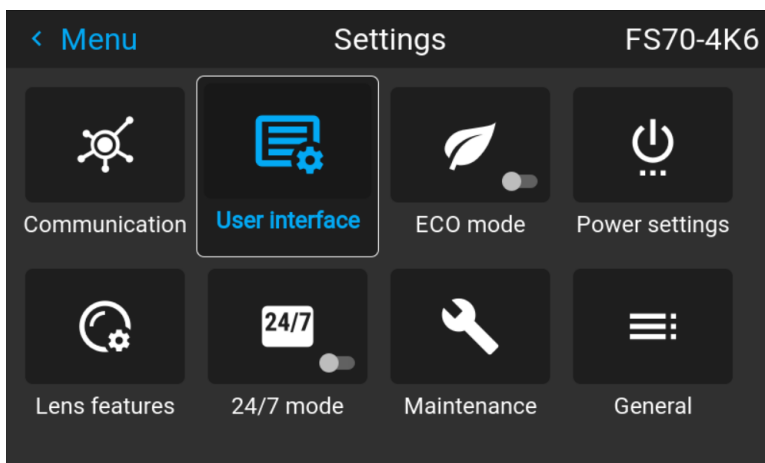

Image 10-1

10.1 Communication

About

Settings / Communication / LAN

Network connection is required to communicate with the projector via LAN or Internet.

Current Ethernet communication information is given, and can be edited in this menu.

Default mode for Ethernet communications are: Automatic ON / IP Version 4 DHCP mode.

Setting	Description
Automatic	
ON	DHCP enabled
OFF	Static
IP version 4	
Static mode	Set address, subnet mask and default gateway according to network specification.
DHCP mode	Assigned IP address, subnet mask and gateway.

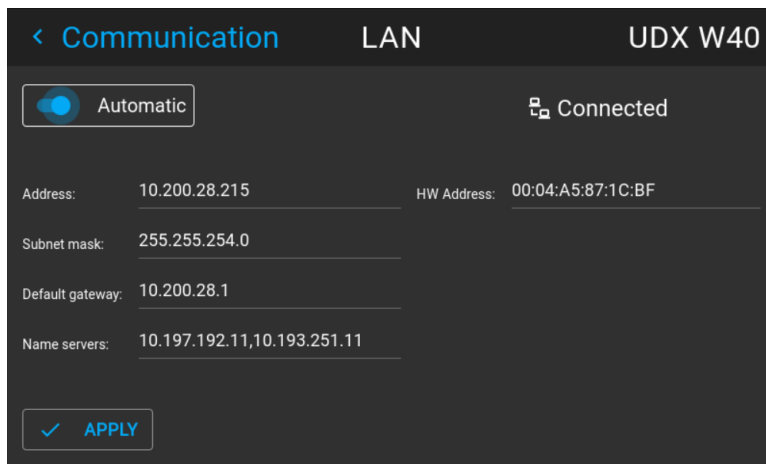

Image 10-2

Manually set up the IP address

Go to the menu *Settings / Communication / LAN*

Enable the Auto zone on the display and press enter. The Auto zone will change to “Manual”.

Scroll down, and modify the desired fields. When in the desired fields, press “Enter” to enable the virtual keyboard, enter the desired values, and press “Enter” again to confirm the change.

10.2 IR control

10.2.1 Broadcast address

About broadcast address

Broadcast address is a common address that can be set on the projector. That can be “0” or “1”. The default broadcast address is '0'.

Any command coming from an RCU programmed with that common address will be executed.

How to the broadcast address

1. In the main menu, select *Settings* → *Communication* → *IR Control*.

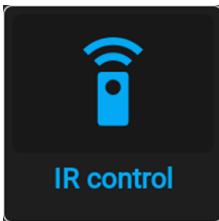

Image 10-3 Communication menu, IR control

The IR control menu is displayed.

2. To change the broadcast address select the radio button of your choice.

The following choices are possible:

- Generic IR (address 0)
- Barco broadcast IR (address 1)

3. Select **APPLY** and click **OK** to apply the changes.

10.2.2 Projector address

About individual projector address

As more than one projector can be installed in a room, each projector should be separately addressable with an RCU or with a computer using serial communication. Therefore each projector has its own address. The factory default individual projector address is '0'.

When the address is set, the projector can be controlled with the RCU. Only addresses between 0 and 31 are supported for the RCU.

Next to an individual projector address, each projector has also a broadcast address for group control.

How to change

1. In the main menu, select *Settings* → *Communication* → *IR Control*.



Image 10-4 Communication menu, IR control

The IR control menu is displayed.

2. Select the current projector address and enter a new address.
3. Select **APPLY** and click **OK** to apply the changes.

From now on the projector will only listen to this new address and to its broadcast address.

10.2.3 IR sensors

What can be done?

Each IR sensor can be individually disabled or enabled.

When all sensors are turned off, the projector will no longer respond to signals from the remote control. To re-enable the sensors, use the menu keypad on the projector.

How to disable

1. In the main menu, select *Settings* → *Communication* → *IR Control*.

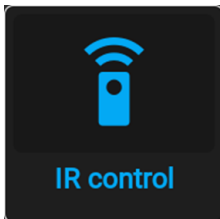

Image 10-5 Communication menu, IR control

The IR control menu is displayed.

2. To disable an IR sensor, select the slider and drag to the left.
A blue slider means an active IR sensor.
A gray slider means an inactive IR sensor.
3. Select **APPLY** and click **OK** to apply the changes.

10.3 Setting a custom projector name

What can be done?

The default name of the projector is “Pulse”. However, you can change this name to make it easier to spot in a network with multiple devices or projectors

How to set a different Host name

1. In the main menu, select *Settings* → *Communication* → *Host name*.

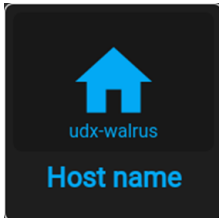

Image 10-6 Settings menu, host name

The Host name menu is displayed.

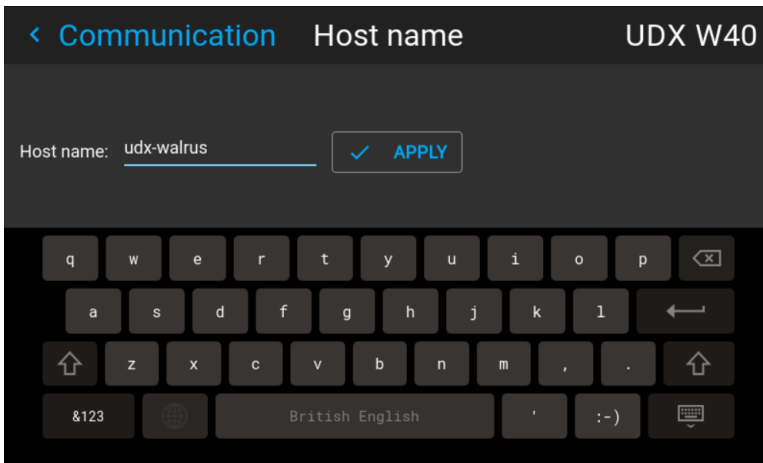

Image 10-7 Example of the host name menu

2. Press confirm to edit the *Host name* field.
3. Use the digital keyboard to change the Hostname to the desired custom name.
4. Press the *OK* key, or press the enter icon to confirm the typed name. Click *Apply to update the host name*.

10.4 Trigger

About

There are 3 trigger outputs (2 on the F40 series) on the projector; one in the front and two on the back panel.

These outputs can be used for controlling external equipment.

The trigger outputs can be individually set to active low or active high by entering the menu *Settings / Communication / Triggers*

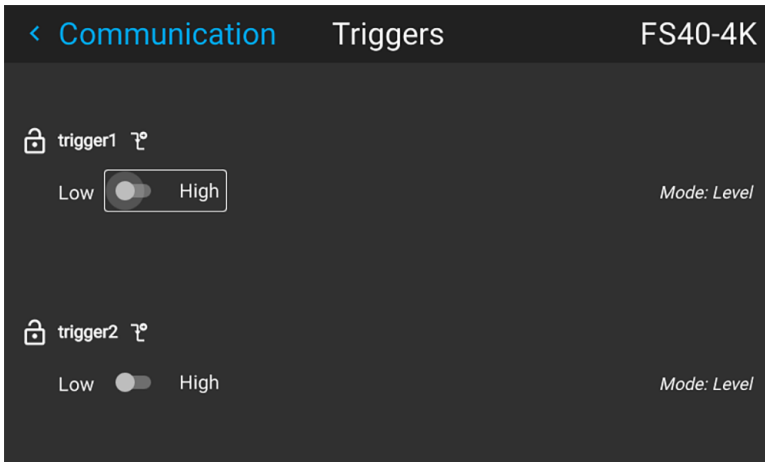

Image 10-8 F40 series trigger menu

The time of trigger output is defined via an API code. Contact Barco support for detailed info.

10.5 Language

Setting the menu language

The menu language can be changed to a suitable language.

Enter the menu *Settings / User Interface / Language*

Use the arrow keys on the remote to select a language.

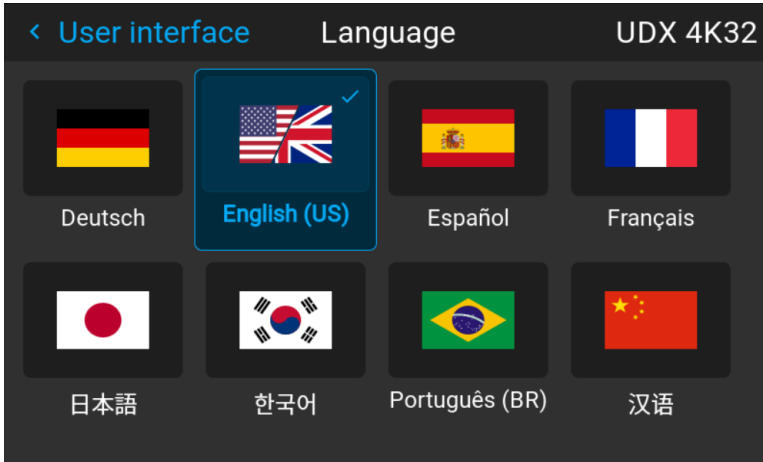

Image 10-9

All menus and icons will change to the selected language.

10.6 Themes

About

Enter the menu *Settings / User interface / Themes*

Themes are used to apply a predefined functionality to the OSD display. There are two options: light (default) or dark. (From software version 1.5, the “Dark” theme is the default.)

It is the “Dark” option that is shown in the menu screenshots in this manual, as this gives a better rendering.

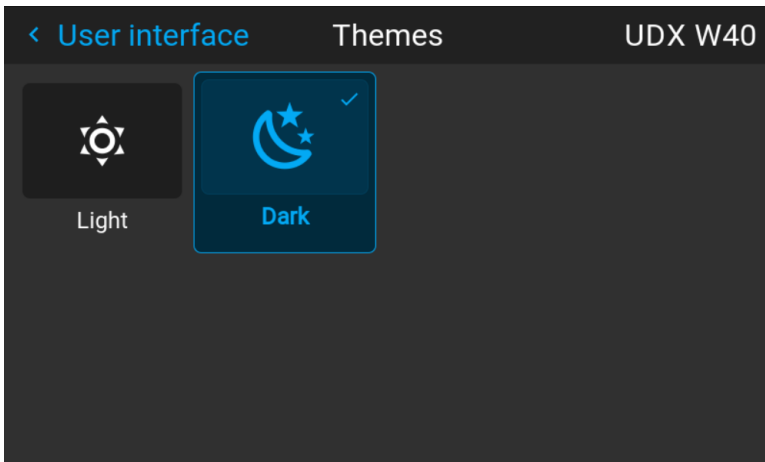

Image 10–10 Select theme, dark or light.

10.7 Units

About

Enter the menu *Settings / User interface / Units*

Units are used to set the preferred units of measurements for temperature and distance.

Enter the menu and select the preferred units by the arrow keys on the remote control.

Temperature units: Celsius (C) and Fahrenheit (F).

Distance units: Meter (M), Centimeters (C), Feet (FT) and Inches (IN)

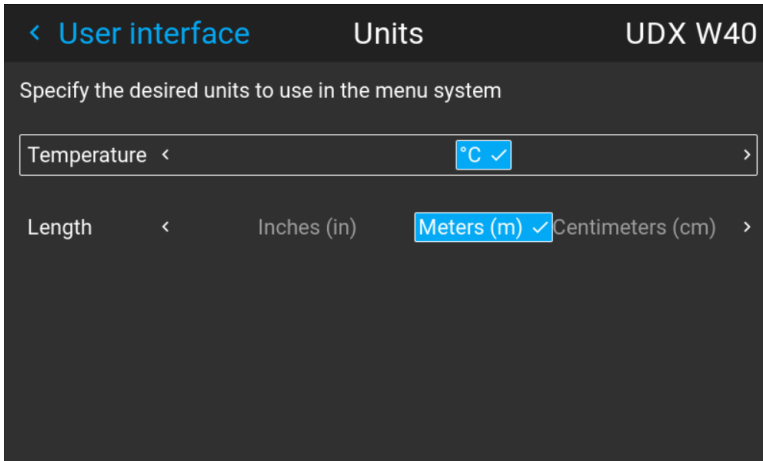

Image 10–11 Select temperature unit

10.8 Backlight

About backlight settings

Enter the menu *Settings / User interface / Backlight*

The backlight menu shows up.

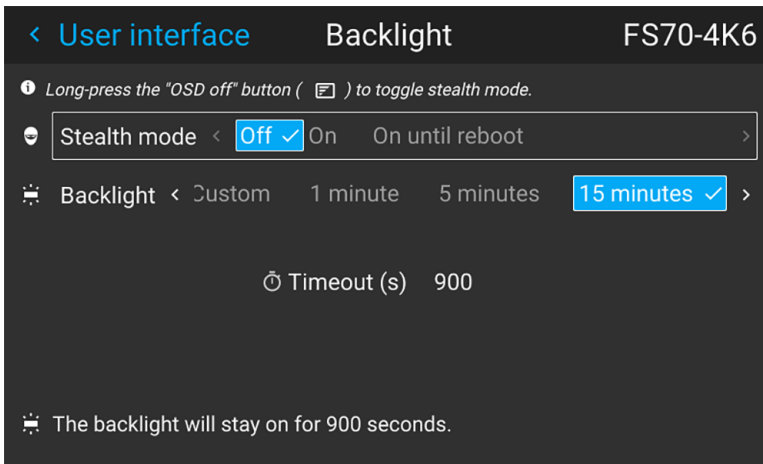

Image 10-12

Setting the backlight modes

- **Stealth mode** : With this enabled, the backlight on the LCD and the buttons will be always off. The indication LED's for the HDbaseT and LAN will also be disabled. When "On until Reboot" is enabled, the backlight on the LCD will be on during reboot, and on power transition cycle (on/ready state to eco mode, and back again).
- **Backlight**: Select the time delay for turning off the LCD backlight. There are several predefined values, and also possible to set a custom value.

10.9 Power settings

About power settings

If the power is off, and there is no activity, the projector will go to standby after a defined time.

Set Power settings timeout

In the power settings menu, the standby timeout can be selected.

Enter the menu *Settings / Power settings*

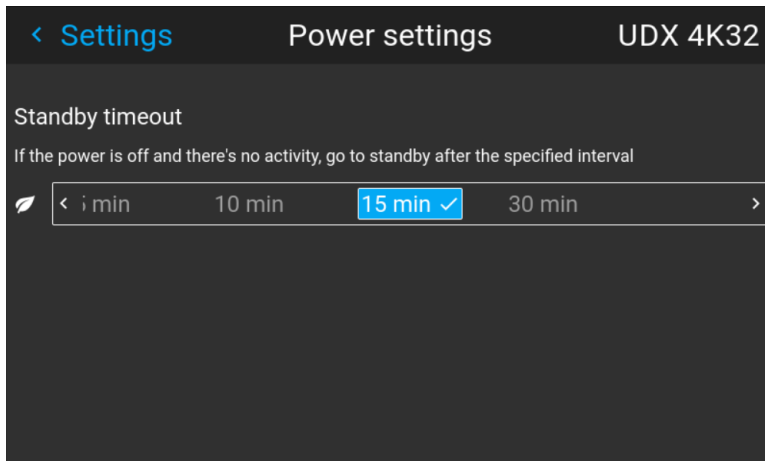

Image 10-13

Select the desired time bu the arrow keys on the remote control, and press enter.

10.10 Lens features

About

In order to prevent unintentional lens adjustments, especially after e.g. a completed setup and adjustment, there is a possibility to disable certain lens adjustment functions. These functions are directly accessible via the remote control, and can by that easily be adjusted by accident.

Enter the menu shown below, and disable the desired functions by toggling the desired buttons. The menu below shows all lens options in enabled position.

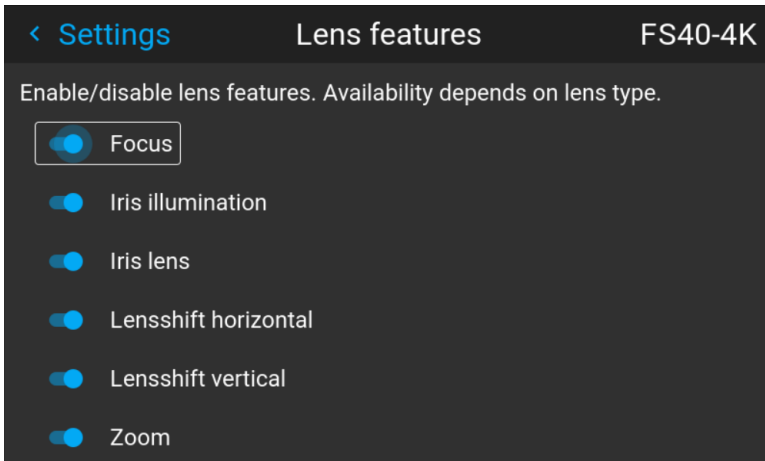

Image 10-14

10.11 Maintenance

About

Settings / Maintenance

The Maintenance Menu is for service personnel and / or advanced users only. Sub –menus are Reset and Lens Calibration.

By entering a service code (or advanced user code), more features are available. This features will be visualized via the new tiles that shows up after entering the code.

See the Service Manual for detailed information regarding service issues.

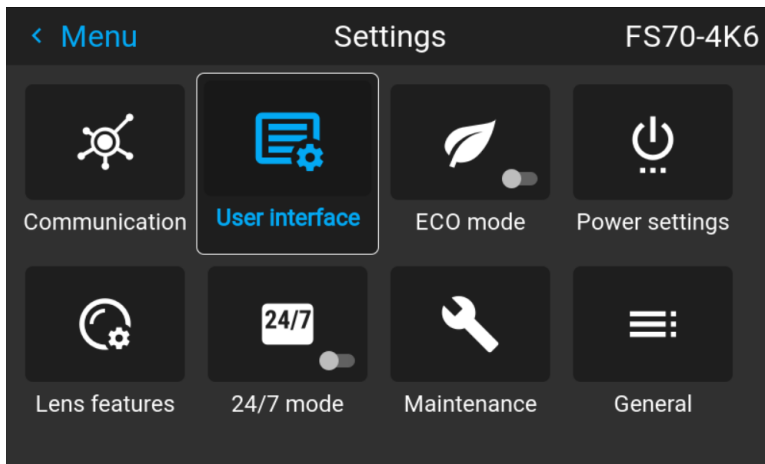

Image 10–15 Maintenance Menu

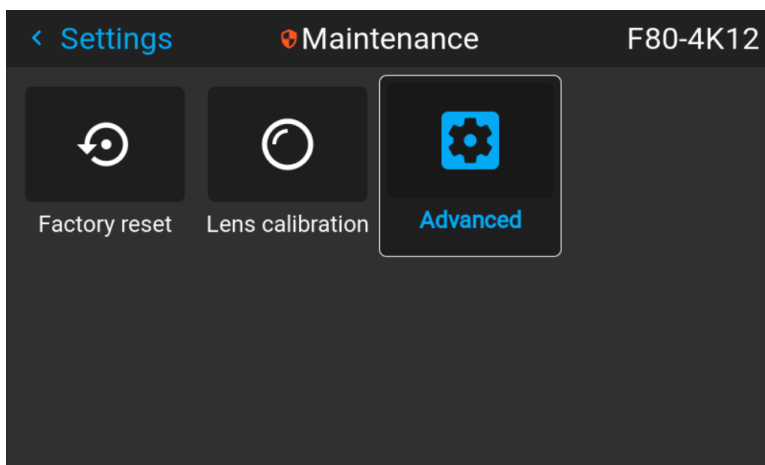

Image 10–16 Maintenance Sub-menu

10.12 Lens calibration

About calibration

This function will calibrate the position of the iris and the horizontal and vertical lens shift. The purpose is to have an accurate feedback to the system

Calibration

1. Enter the menu *Settings / Maintenance / Lens calibration*.
2. Select the feature that shall be calibrated, and press enter on the remote control

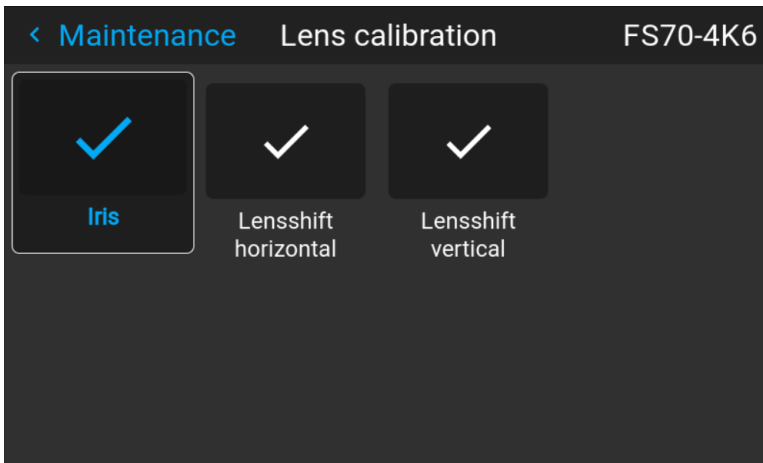

Image 10-17

3. Press enter to execute.

10.13 Controlling the backlight of the LCD Display

What lighting can be controlled?

You can choose how quickly the backlight of the LCD turns off. You can select one of the default values, or enter a custom value.

Stealth Mode

Alternatively, you can turn on **Stealth Mode** instead. By activating this mode, the backlight of the LCD, the backlight of all the buttons of the keypad and the indication LEDs for the LAN and HDbaseT inputs will be disabled

Stealth Mode is enabled and disabled by pressing the OSD button on the remote control for 3 seconds.

How to set the backlight

1. In the main menu, *Settings* → *User interface* → *Backlight*.

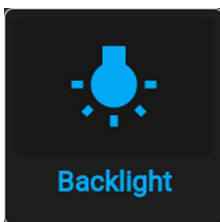

Image 10-18 Settings menu, backlight

The Backlight menu will be displayed.

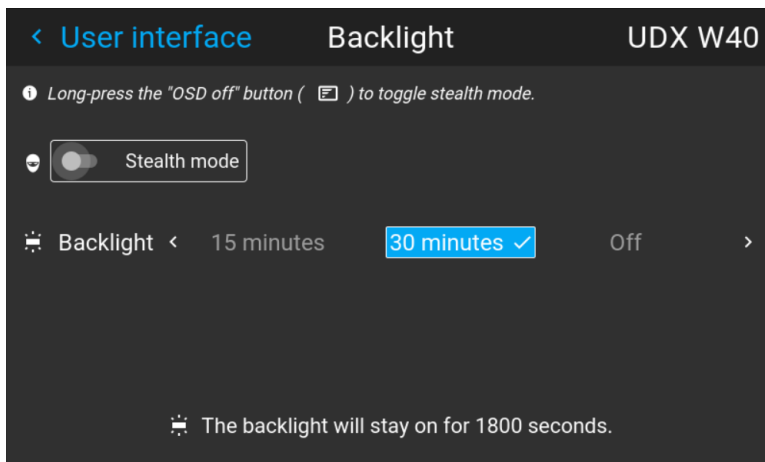

Image 10-19 Example of the backlight menu

2. Choose the desired setting for the backlights. Select one of the predetermined options, or a custom value.

GUI – Status menu

11

11.1	Status menu overview.....	166
------	---------------------------	-----



No settings can be modified in the status menu. Its only for consulting.

11.1 Status menu overview

How to access the status menu

While in the main menu, press Status.

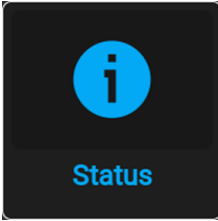

Image 11-1 Main menu, status

The status menu is displayed.



Image 11-2 Example of a status menu

Swipe the screen to switch between the Status and About page.

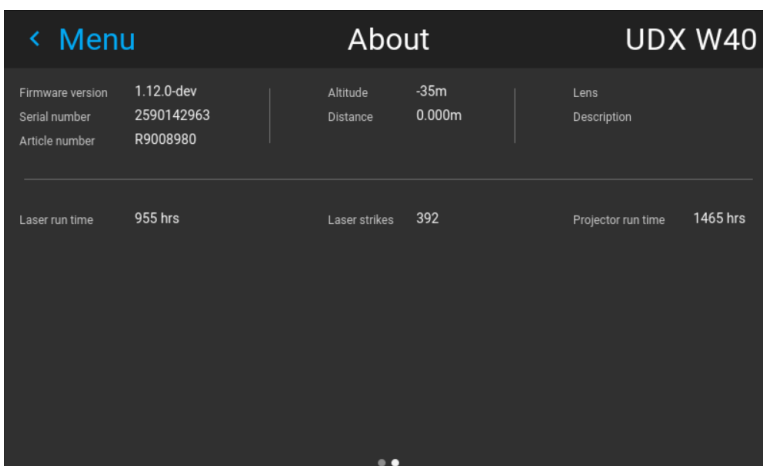

Image 11-3 Example of the About page in the Status menu

What can be seen on the Status page?

- Connected source and signal details
- Display settings (e.g. Display mode, transport delay, output resolution, etc)
- Projector power and environmental details (e.g. power, temperature, pressure, etc)
- Network status (e.g. host name, IP address, software version)
- Active function icons (e.g. warp, blend, files, etc).

What can be seen on the About page?

- Projector information, e.g. firmware version, serial number and projector article number
- Mounted lens: Type and description
- Basic statistics, e.g. light source run time, projector runtime

3D setup

The projector is capable of displaying 3D images and movies in both active and passive stereo 3D input mode. Setup of a 3D installation requires an advanced understanding of the 3D systems, both for the projector, and also for the signal source.

Regarding setup of the signal source, refer to the user manual for the specific unit.

In 3D setup, it is crucial that the projected images are perfectly synchronized through the whole signal path, from the signal source to the picture viewed through the 3D goggles.

See instructions in this chapter to set up the projector for this feature.

Active stereo input.

One channel input. (One cable). Update frequency @ 120 Hz. Extra sync. signal must be used when DVI source is used. For Displayport source, the sync signal is present in the signalcable, but external sync can also be used when necessary.

Passive stereo input.

Use two channel input (two cables), one for each eye. Update frequency limited to 60 Hz for each channel. Dual Sequential input source (DVI or Displayport) must be used. No external sync signal required.

Index

Numbers/Symbols

16:9 to center function 103
3D 140, 169
4K 89

A

About warping 113
Adjust
 focus 106
 iris 106
 zoom 106
Advanced blend 137
Advanced image adjustments 86
Advanced picture adjustments 97
Alignment
 Warping
 Bow 119
 Files 123
 Latency Control 125
 On/Off 113
 Screen size 115
Approved lenses 26
autostereo 140

B

Backlight
 Control 164
 LCD Display 164
Backlight settings 159
Basic blend 127
Basic blend setup 130
Black level adjustment 132
Blend 127
Blend mask setup 128
Blending
 Black level adjustment
 Files 135

Black Level Files 135
Blend files 136
Bore sight adjustment 46
Brightness 78
Brilliant color 90

C

China RoHS compliance 18
CLO 138
Color level adjustment. 134
Color Primaries 94
Communication 150
 IR control
 Broadcast address 151
 IR sensors 153
 Projector address 152
Connections 50
 making 49
Connector 51
 specifications 50
Connector selection 70
Connector settings 71
Contrast 77
Control Interfaces 53
Create profile 145
Cropping the image 98
Custom projector name 154

D

Digital Shift 85
Digital Zoom 83
Digital Zoom Shift 83
Display setup
 IG pixel shift 139
Displaying HDR content– Perceptual Quantizer (PQ) 91
Disposal 16

E

Edit the RealColor presets. 87

F

Focus
adjust 106

G

Gamma 81
Gamma types 82
General considerations 10

H

HDBaseT 53
HDMI 52
HDR PQ tone mapping (Light) 92
HDR Status. 93
Host name 154

I

IG pixel shift 139
Image 127
 brightness 78
 contrast 77
 saturation 79
Image menu 75
Important safety instructions 11
Importer 21
Inspection
 Initial 35
Installation
 positioning 36
Installation conditions 33
Installation menu 105
Installation process 32
IR control 151
 Broadcast address 151
 IR sensors 153
 Projector address 152
Iris
 adjust 106

K

Kaledescape 102

L

LAN/Ethernet 55
Language 156
Lens 106
 Scheimpflug 45
Lens calibration 163
Lens features 161
Lens lock 29

Lenses 25
Location of labels 15
Lock the lens 29

M

Manual Cropping 100
Measurement units 158
Mounting surfaces 38
Mounting the projector, general considerations 37

N

Nightvision 95

O

On Screen Display 68
Orientation 109
OSD 68
Output resolution 89

P

P7 Realcolor 86
Physical installation 31
Positioning the projector 36
Power 160
 down 49
 modes 49, 66
 up 49
Power down 58
Power mode transitions 59
 General 59
 Going from ECO to ON 64
 Going from ON to READY 62
 Going from READY to ECO standby 63
 Going from READY to ON 61
 Plugging power cord 60
 Power on projector 60
Power on 57
Power up 57
Predefined Gamma types 82
Preset Crop mode 99
Product Info 23
Production Address 22
Profile setup matrix
 Profile 143
Profiles
 Introduction 142
 Preset variables 141
Projector
 power down 49
 power modes 49
 power up 49
Projector safe attachment points 39
Projector source and control connections 50

R

Removal of the front cover 41

Replace a lens 27
RS-232 54

Zoom / Focus 106

S

Safety
 Environment 9
Safety symbols 14
Saturation 79
Scaling modes 110
Scheimpflug 45
 Adjustment points 45
Scheimpflug adjustment 46
Scheimpflug's law 45
Service 162
Set up the system 128
Settings
 customize 67
Sharpness 80
Shift 107
Shift to center 108
Shortcut keys 49
Signals 50
Source menu 69
Specifications 50
Start up 49
Statement 24
Status menu 165
 Overview 166
Stealth mode 164
Swap channels 95
System settings
 menu theme 157
System Settings
 Communication
 IR control 151
System settings menu 149

T

Taiwan RoHS compliance 20
Throw distance 42
Trigger 155
Turkey RoHS compliance 17

U

USB-A 56
User interface 68
Using dual inputs 74

W

Wake On LAN (WOL) 65
Warp 113
Warp – 4 Corners adjustment 117

Z

Zoom
 adjust 106

